



OFFICIALLY
LICENSED
PRODUCTS
2015







Lost Camo® was designed to be effective across a wide range of topography and geographic locations. The distinctive high contrast, multi-directional foreground creates a 3-dimensional effect, while the backgrounds combine various shadows, colors and textures to form highly versatile camouflage.

Several leading brands within the outdoor and bowhunting industry utilize Lost Camo® for both a stunning look on the shelf as well as unsurpassed effectiveness in the field.

For more information regarding Lost Camo®, it's partners, or to locate a retailer that carries its products, visit www.lostcamo.com.

**Get Lost,
or Be Found.™**



LOSTCAMO.COM



F E E L T H E



The 2015 NO CAM™ HTR is engineered for accuracy and delivers a

F U T U R E



radically smooth and balanced feel. **NOCAM™ HTR**

NO CAM™ HTR

NO CAM ST™ Technology (patent pending) put every other component into question when designing the new NO CAM™ HTR. The result is a truly integrated system featuring shorter, more rigid quad limbs, a less reflexed riser, twin Harmonic Stabilizers™ and our patented Focus Grip™. RockMods™ come standard on the NO CAM™ HTR and are available in 65%, 75% and 85% let-off. Choose between five exclusive finishes, including the new Stone Tactical and Lost Camo® OT.

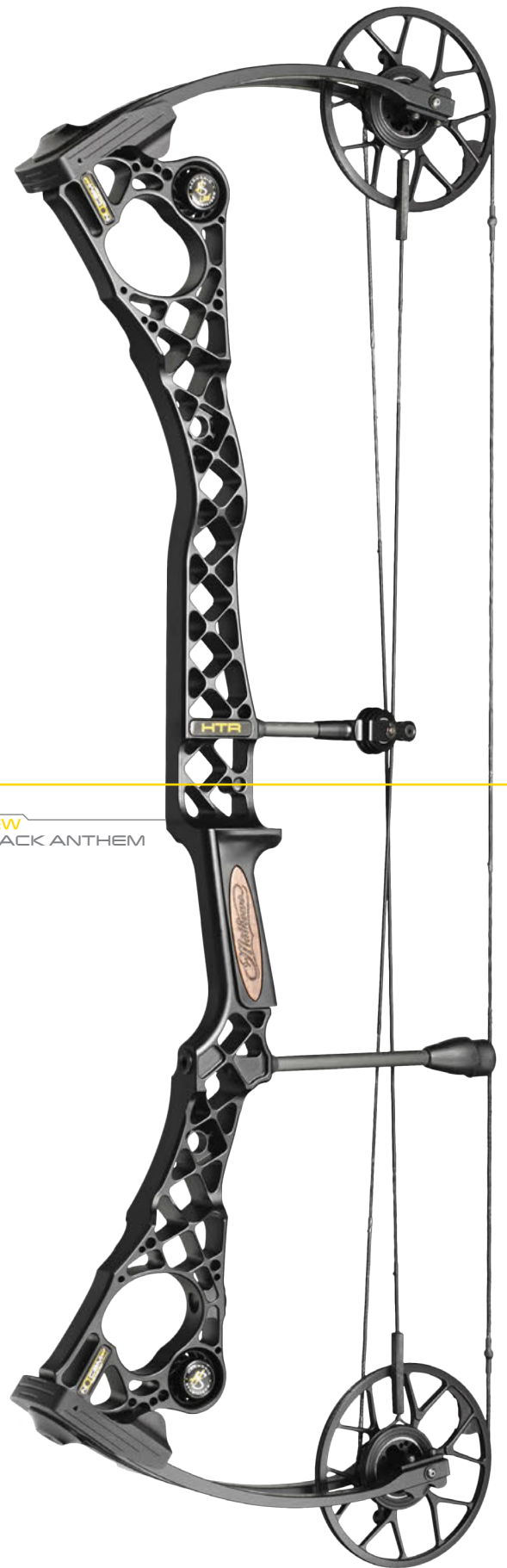
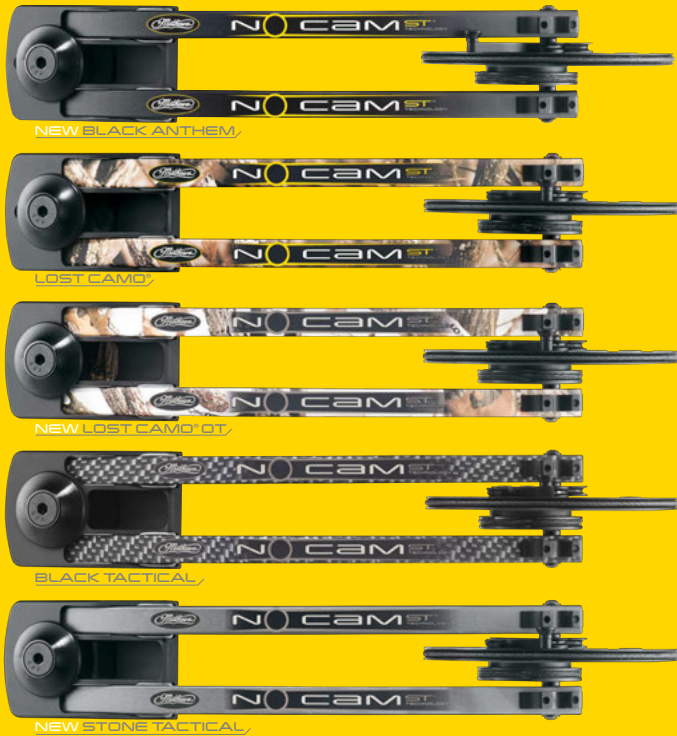

NO CAM ST TECHNOLOGY

Up to 330 @ 65% • Up to 325 @ 75% • Up to 321 @ 85% • Axis to Axis 32" • Brace Height 6 5/8" • Physical Weight 4.14 / 4.3 lbs.** • Let-Off 65, 75, 85% • Draw Weights 50, 60, 70 lbs. • Draw Lengths 24 - 30" • Half Sizes 24.5 - 29.5" • Base MSRP \$1099

All specifications are approximate



LOST CAMO®

HTR



NEW
LOST CAMO® / OT

HTR



BLACK TACTICAL

HTR



NEW
STONE TACTICAL

HTR

** 4.14 lbs with 2 Harmonic Dampers™ / 4.3 lbs with 2 Harmonic Stabilizers™

ARROWWEB®
CT-SERIES QUIVER



NEW Lost® DT



Tactical



Black



Quick Release Grip

Created for fast and easy arrow access.



Custom Color Hood Inserts

Personalize your CT-Series Quiver with custom color inserts. Available in 10 colors. Each CT comes standard with black, red and blue. (excluding tactical)



Redesigned Foam Inserts

New foam designed specifically for most expandable broadheads and fixed blades 1-1/8" and under.



Harmonic Damper®

Mathews® Harmonic Damper® absorbs residual sound and vibration.



Detachable Blade Protector

Developed for use with most expandable broadheads, the blade protector helps keep your blades sharp and you safe.



GridLock™ Structure



Spider Claw® Quiver Mount

Quickly and easily mount the CT Quiver with the exclusive Spider Claw® System.



Available in 4 or 6 Arrow Configurations

CUSTOM DAMPING®
ACCESSORIES

Personalize your Mathews® with Custom Damping Accessories®. Available in 10 different colors, these rubber accessories not only absorb vibration and reduce noise, they also look amazing on your bow. If that's not enough, put on a couple Monkey Tails™, the do-it-yourself string and cable damping system. They install in seconds and no bow press needed.





HARMONIC STABILIZER®

The Harmonic Stabilizer® and Harmonic Stabilizer® Lite reduces post-release vibration by up to 75%, and the Harmonic Stabilizer® Lite is nearly 70% lighter than the original.

MATHEWS® GENUINE ULTRA-REST



Full Containment

The Ultra-Rest® provides total arrow containment, even with a slow let-down.

Harmonic Damper®

Easy Adjust Timing Cord

Thumbwheel



ARROWWEB® T-SERIES QUIVER

The T-Series ArrowWeb® Quiver is the quick and easy way to attach and detach your quiver. The foam insert accommodates 5 fixed blade or expandable broadheads. The ArrowWeb® easily converts to right or left-handed set-ups, and adjusts for long arrows. Available in Black, Tactical and Lost Camo® finishes.



DEAD END® STRING STOP

The Mathews® Dead End® drastically reduces residual vibration and virtually eliminates post-release noise. Fits most bows currently equipped with a rear stabilizer bushing and installs in minutes.



FOCUS® GRIP

The Mathews® Focus® Grip's patent pending "Focus Ridge" optimizes hand placement, and minimizes hand torque by keeping pressure in the center of the grip. Available in 9 custom colors.



ARROWWEB® FP-SERIES QUIVER

FP-Series ArrowWeb® Two-Piece Quivers come in both 5 and 7-arrow configurations, for right or left handed shooters and easily mounts in minutes. The quiver hood holds a foam insert that accommodates both fixed blade and expandable broadheads. Available in Black and Lost Camo® finishes.



MISSION[®] CRAZE[®]

The Mission[®] CRAZE[®] is loaded with hyperadjustability and lethal performance for any age or experience level. \$299 MSRP.

2015

finish options



specifications

All specs approximate

Speed Rating // 306 fps
Weight // 3.6 lbs
Draw Weights // 15-70 lbs
Draw Lengths // 19-30"
Let-Off // up to 80%

Axle-to-Axle // 28"
Brace Height // 7.5"
Riser // Extruded
Suppression // D-Amplifier™

Grip // Composite
Bowstrings // Zebra[®] Hybrid
Cam // Dual / Adjustable
Cable Guard // Composite Rod

CUSTOMIZE YOUR MISSION®

Remember deer only see in black & white, so if you're not into standard camo, consider customizing your bow with one of our new "Splash" finishes. With just enough color to set you apart from the rest and the breakup in pattern you'll need to blend in to your surroundings, these patterns are a fun way to be both unique and effective in the field.

Other custom finishes available on select Mission® bows:
(see the Mission® Catalog for details)

additional custom colors



PINK SPARKLE

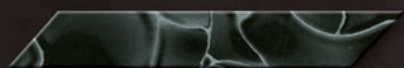

BLACK SCALE



BLUE GATOR



PURPLE SPLASH

GREEN SPLASH

ORANGE SPLASH

PINK SPLASH

MISSION
BY MATHEWS®

*See authorized retailer for pricing on custom colors

FIND A RETAILER AT MISSIONARCHERY.COM

NEW FOR 2015

MXB®-SNIPER LITE™

Extremely light-weight and balanced, the new MXB®-Sniper Lite™ features our patent-pending Sync Cam™ for reliable accuracy and enhanced durability. This innovative system not only synchronizes the cams for precision timing, it also has higher let-off, which puts less pressure on the string servings, increasing their lifespan. The Sync Cam™ system allows you to easily draw this crossbow by hand, and because the cams are synchronized, it automatically finds center at full draw. The MXB®-Sniper Lite™ also features the new, patent-pending Smart Guide™ cable slider, which angles up as you come to full draw, reducing pressure and torque on the cams, further ensuring long-lasting accuracy. Shooting up to 310 fps, the MXB®-Sniper Lite™ is an incredibly versatile and reliable crossbow available for \$599.

2015





specifications

All specs approximate

Speed // Up to 310 fps
Physical Weight // 5.96 lbs
Width // 20.5" (not Axle-to-Axle)
Length // 32.75"
Powerstroke // 14"

Draw Weight // 150 lbs
Finish // Black Tactical
Bowstrings // Zebra® Hybrid
MSRP // \$599 (bow only)

FIND A RETAILER AT MISSIONARCHERY.COM



Helping kids draw out their inner hero.



Genesis®, the official bow of the National Archery in the Schools Program.

Through our exclusive partnership with NASP, Genesis™ bows are helping millions of young archers enhance confidence, focus and discipline.

- **NASP® is still growing!**
Over 10 million students from over 10,000 schools in 47 states and 6 countries have participated in NASP®.
- **Everybody can shoot.**
Success is not based on physical ability, but on individual skill.
- **Archery engages students.**
Regardless of age size or gender, and helps improve academic performance, attendance and behavior.

The Genesis™ bow, available in a wide range of colors.



Over 10 million kids have shot a Genesis.™

The revolutionary Genesis™ bow is giving kids all over the world a new sense of adventure, and with revolutionary features like, Zero Let-Off Technology Genesis™ bows offer advantages that make them a perfect choice for archers of any age or size. Because the draw length is always “right,” beginning archers can’t develop bad habits caused by an improperly fitted bow, and since there isn’t any specific draw length, kids can’t outgrow it. Built to last, Genesis™ bows are manufactured with a tough, aluminum riser and durable composite limbs to provide a lifetime of adventure... **Join the Revolution!**



genesisbow.com





Introducing Zebra[®] Trophy, The Most Advanced Bowstrings & Cables You Can Shoot.



After nearly 20 years of research and development we are proud to present the most advanced bowstring we've ever produced.

Our all new proprietary Trophy Process, combined with an ultra premium blend of BCY material, have produced a new string and cable with all the qualities today's archer's demand.

And, Zebra[®] Hybrid uses an advanced blend of BCY material that's designed to be the high performance, hassle free bowstring and cable for you.

Zebra[®] Trophy truly is the professional's choice.

zebrastrings.com



New Zebra[®] High Performance Bowstring Wax

Increase the longevity and performance of your premium bowstring by applying Zebra[®] performance wax to your strings and cables regularly. Zebra[®] High Performance Wax is a unique formula designed to condition your strings and cables, which will help maximize the performance and life of your strings and cables.



Mix or match any 2 of these 34 amazing custom colored strings to create a look that matches your style.





POWERTEXGROUP

DIESEL
M14A-H74
Mathews® Logo Mesh
Back Cap.
Snap back. Unstructured.



RALLY
MM14A-H71
Mission® Logo Black Full
Back Cap.
Velcro Closure. Unstructured.



**SHED
HUNTER**
M14S-M92
This 65/35 cotton/poly tee is
sure to turn heads. Fitted Cut.
Sizes: M, L, XL, 2XL.



MENACE
MM14S-M80
Mission® Logo black skull
tee. 100% pre-shrunk cotton
fitted tee.
Sizes: M-2XL.

MIDNIGHT
M14A-S62
Stay warm in this
heavyweight navy heather
pullover hoodie with a
applique Mathews® logo.
55/45 cotton/polyester.
Sizes: M, L, XL, 2XL, 3XL.



SLATE HOODIE
MM14E-S84
Mission® M Block Logo applique
Hoodie. 80/20 cotton/poly hoodie.
Sizes: M-3XL.





CORE XTREME TECHNICAL VEST

M12A-LC409

The Core Xtreme Technical Vest is a great mid-weight vest for layering or worn alone. Silent, soft, lightweight, and warm this vest is your new favorite. 100% Polyester shell is water resistant, windproof yet breathable and lined with odor reducing Silver fleece with antimicrobial treatment to minimize human odor. Vest offers a total of 8 pockets to keep all your gear close. Dual access pockets, waterproof zippers plus added hand warmer pockets.



CORE XTREME TECHNICAL JACKET

M12A-LC408

The Core Xtreme Technical Jacket is an awesome mid-weight jacket. Silent, soft, lightweight, and warm this jacket is your new favorite. 100% Polyester shell is water resistant, windproof yet breathable and lined with odor reducing Silver fleece to minimize human odor. Jacket offers a total of 8 pockets to keep all your gear close. Dual access pockets, arm pit zippers for airflow, waterproof zippers, hand warmer pockets.



CORE XTREME TECHNICAL PANTS

M12A-LC411

Our Core Xtreme Technical Pants are the perfect mid-weight pants. Silent, soft, lightweight, and warm. 100% Polyester shell is water resistant, windproof yet breathable and lined with odor reducing Silver fleece with antimicrobial treatment to minimize human odor. Dual access pockets with zippers for gear.



SILVER XTREME HEAVY WEIGHT RAGLAN 1/4 ZIP SHIRT

M12A-LC626

This Silver Xtreme Long Sleeve 1/4 Zip Heavy Weight Raglan Shirt is designed as the ultimate choice for cold weather hunts. Lightweight, breathable, 95% Polyester and 5% spandex construction adds moisture wicking abilities and core body temperature regulation. 1/4 zip design allows you to warm up or cool down. Spun in Silver Xtreme fibers feature odor fighting antimicrobial treatment to keep human scent to a minimum.





Hunting wear is all we do!®



**MONSTER™ WATERPROOF
FLEECE JACKET**

MSJ

It's made of HyperHide H20™ so it's as quiet as it gets. The waterproof/breathable HydroCore™ laminate enables you to weather any storm. Insulated with Heat Tech™ so you'll stay warm when the temperature drops. And, it features Gamehide's exclusive Freedom Sleeve™ for unmatched mobility.

**MONSTER™
WATERPROOF
FLEECE BIB**

MSB

It will keep you warm and dry thanks to the HydroCore™ laminate and Heat Tech™ insulation. Full leg waterproof zippers make it easy to get on over boots and a two-way front zipper allows easy access.



**GRID LOCK®
JACKET**

MB9

**GRID LOCK®
PANT**

MB2

The perfect mid-weight bowhunting jacket and pant combination. Soft and silent, it's everything you need on all but the worst weather days.





MATHEWS® LOGO HIGH PERFORMANCE HOODIE

MFH

Made from our performance fleece, it's soft, silent and wicks moisture. It's a great layering piece for cold weather hunts or can be worn alone as a casual or early season piece.



WICKED TEE

MBS

Warm weather is never fun while hunting. The Wicked Tee combats the elements with its lightweight, breathable wicking fabric in Lost Camo®. This draping tee will be your new go-to outer garment for those warm early season hunts in the fall and gobblers in the spring. Many hunters also use the tee to throw over a heavier fleece when it's just not cold enough for your Grid Lock!



WICKED LITE PANT

M33

This pant just plain hunts! Our woven poly fabric breathes well, dries fast, resists burrs and is built for comfort. This new design includes front slash pockets, dual rear pockets plus a utility pocket on the right side. An elastic section in the waist allows for a great fit while the articulated knees let you move freely. Belt loops on waist and zippered fly with post closure round out a great pant.



APEX SKULL CAP

MSK

During the rut when hunting is best you need to stay warm to stay on the stand. The best way to stay warm is with the Apex Skull Cap with Thinsulate Flex Insulation. This skull cap fits your head like a glove and looks very sharp.



APEX NECK GAITER

MNG

When the mercury drops the deer action heats up, stay warm and stay on the stand longer with the Apex Neck Gaiter with Thinsulate Flex Insulation. If you have never worn a neck gaiter, you are missing the boat. No other accessory can help you stay on the stand longer than a neck gaiter.





SCENTLOK
TECHNOLOGIES

FULL SEASON VELOCITY JACKET

- Carbon Alloy® technology
- DWR Treated shell repels water
- Five pockets for essential gear storage (3 outer and 2 inner)
- Safety harness access opening
- Micro-fleece liner for added warmth and comfort



VELOCITY SHOOTERS GLOVE

Our popular shooter glove is now available in a weather resistant version. Light enough to allow for great dexterity, yet warm enough to keep you comfortable in the stand.



FULL SEASON VELOCITY PANT

- Carbon Alloy® technology
- DWR Treated to repel moisture
- 8 pocket design without noisy velcro or buttons
- Inner thigh gusset for improved mobility in the field
- Gripper waist for a secure fit



FULL SEASON ULTIMATE HEADCOVER

A SCENTLOK cap with the headcover built right into the design. Easy pull down hinged facemask for calling or anchoring a shot.



Blazin Creationz

LLC
APPAREL - AWARDS - BANNERS-N-SIGNS & MORE

LIMITED EDITION TROPHY LADIES V-NECK TEE

MLT6425

4.2 Ounce 100% Combed
& Ring Spun Cotton, Side
Seamed, Missy Fit.

Sizes: Ladies: S - 2XL



FRONT

BACK

LIMITED EDITION TROPHY COTTON TEE

MLT54

5.4 Ounce 100% Cotton

Color: Sand or Black

Sizes: Adult: S - 4XL



FRONT

BACK

LIMITED EDITION LOST CAMO® EDITION BUCK TEE

LCBP54

5.4 Ounce 90/10 Cotton/Polyester

Color: Gravel

Sizes: Youth: M, L / Adult: S - 4XL

EMBROIDERED WICKING SPORT SHIRTS

Choice Of Mathews®, Lost Camo®,
or Mission® Logo. Ladies & Mens
available.

3.8 oz 100% Polyester snag resistant.

Various colors available

Sizes: Adult: XS - 4XL



MST654

MST658

LIMITED EDITION TROPHY LONG SLEEVE HENLEY

MLT1401

3.8 Ounce 50/50 Ring Spun Combed
Cotton/Poly.

Color: Charcoal Gravel

Sizes: Adult: S - 3XL



COLOR-SPLICED HOODED SWEATSHIRT

9oz, 65/35 ring spun combed
cotton/poly, Large Embroidered
Applique MSF226LA or Left Chest
Embroidery MSF226E

Sizes: Adult: XS - 4XL



MSF226LA

MSF226E



LC2613
MENS JERSEY
SHORT SLEEVE

LC2717
LADIES JERSEY
SHORT SLEEVE

MATHEWS® LOGO LOST CAMO® EDITION SPORT SHIRT

100% Polyester snag resistant.

Color: Black/Grey, White/Black

Sizes: Adult: XS - 6XL



APPAREL



LEGACY

Available Logo Colors

437979 - ROYAL	437981 - ERIN GREEN
437977 - LIGHT BLUE	437984 - WILD PINK
437983 - SCARLET	437982 - MAIZE
437980 - DARK PURPLE	437988 - BURNT ORANGE



BLACK PEPPER MESH

437969

Trucker Adjustable



BLACK PEPPER MESH

437966

Trucker Adjustable



BLACK OLD FAVORITE

437965

Trucker Adjustable



BURNT ORANGE

LOST CAMO® EDITION EZ TWILL

Trucker Adjustable



EZ TWILL

437960

Trucker Adjustable



DARK GREY EZ TWILL

437964

Trucker Adjustable



NAVY OLD FAVORITE VISOR

437963

Trucker Adjustable



BROWN CUFF BEANIE

437970



BLACK BEANIE

437971



Sami Li™
designs

Officially Licensed
Lost Camo® Edition
Formalwear and handbags.





VO2fx

POWER YOUR LEGS TO THE MAX

LOST CAMO® EDITION PREDATOR HUNTING SOCK

A comfortable sock guaranteed to not fall down your leg! The Predator features Merino Wool and Graduated Compression Technology, which is clinically proven to:

- Enhance blood flow in legs & feet
- Speed athletic recovery
- Help prevent injury & reduce calf cramps
- Provide energizing effect on legs and reduce foot fatigue

Graduated compression also relieves symptoms of plantar fasciitis, restless legs, poor circulation, and more. Seamless construction protects your feet from irritation – no blisters!

Merino Wool provides a soft feel while reacting to changes in your body temp. It will naturally absorb sweat and odors that are normally released during washing.

Our product is proudly made in the USA. We offer a 30-day money back guarantee and a one year warranty.



APPAREL



GET LOST IN YOUR SURROUNDINGS





PURSUIT
BPURLC

Light weight, technical and a breeze to carry - literally. The Pursuit has all the features you will need for a trip to the tree stand or more localized hunts. It accommodates water bottles or a hydration bag, along with five storage pockets and a set of bedroll straps.

- Water bottle pockets
- New AirTrack™ suspension
- Hydration compatible



Badlands



MONSTER
BMFLC

Why did we call it the Monster? Perhaps it's the 1000+ cubic inches of storage or maybe that is has more features than any other fanny pack ever developed. But mostly it's because when we wear it we feel like a Monster... a monster that can and will hunt anything with success.

- Flex-frame
- 3 point adjustable shoulder straps
- Hydration Compatible
- Molded foam suspension



SUPERDAY
BSDPLC

The Superday is one of the best all-round hunting packs we make, period. When your hunt calls for a do-it-all daypack, rely on the Superday. With the batwing compression system, rifle and bow carrying capability and built-in sidearm holster, the Superday keeps your mind on your hunt and not on your gear.

- Adjustable rifle boot
- Pistol holder
- Molded foam suspension
- Hydration compatible

2200
B22LC

If there is one product that best personifies "the spirit of Badlands®", it is the 2200. Fast, passionate, in love with technology and ready to do whatever is needed to get the job done. This was the pack; that some twenty years ago, started it all- and was the very first model to bare the Badland's name.

- Redesigned for 2014
- T-6 Aircraft aluminum frame
- Built in meat shelf
- Spotting scope pocket
- Front entry suspension



ARCHERY ACCESSORY CASE
LOST CAMO® EDITION
C-215

- Keeps all of your accessories secure and organized
- Fits in separate compartment in the C-275T bowcase



BOWFILE ELITE SERIES

C237-E, C275-E, C245-E

- 18% lighter, yet even stronger than our traditional cases
- Holds up to eighteen arrows in bottom compartment
- Made for the parallel limb style bows
- So sturdy you can stand on it

ARROW CASE
LOST CAMO® EDITION
C-255

- Holds up to 18 arrows
- Fits in separate compartment in the C-237T, C-275T, and C-235 bowcases



SHOWN WITH OPTIONAL C215 ACCESSORY CASE AND C255 ARROW CASE.





ELEVATION™

MATHEWS® LOGO ALTITUDE™ BOW CASE

The Mathews® Logo Altitude Bow Case features our Diamond-Lock and Comfort-Tec Pro technologies to ensure a balanced performance found nowhere else. With a string and cam cradle and multiple bow tie-downs in the interior, your precious Mathews® bow will stay safely and securely in place.

- Comfort-Tec Pro Padding

- Heavy-duty Zippers
- Skid Plates
- Molded Arrow & Stabilizer Pocket
- Deep Pile Micro-Raschel Fleece Lining
- String & Cam Cradle
- Bow Tie-down Locations
- Comfort-Tec Shoulder Strap
- 41" x 21" Interior



Made with Pride in the USA

OTHER QUIVERS & BOWCASES AVAILABLE FROM NEET.

TRIM LITE QUIVER N-TL-400

- Lost Camo® edition
- 21" body
- Four 1" arrow tubes
- Large wing strap pocket
- Two zippered accessory pockets
- Pencil and score card pocket

Available Options: Right or Left Hand



HUNTER'S CHOICE BOWCASE BC-700

BC-700

- Lost Camo® edition
- Brushed Tricot lining
- 10" x 6" center pocket
- 37" x 8" x 4" arrow box pocket
- Thick 3/4" foam padding
- Full wrap around handles with handle wrap
- 14" x 7" x 4" accessory pocket



GamePlan Gear is known for creating innovative packs for all types of hunters. We now offer three of our best-selling products in Lost Camo®, so serious hunters can match all their Mathews® products.



BOWBAT XL

Our best-seller and the most innovative 'pack' in bowhunting - the BOWBAT does it all! Combines your bowcase, bowslings, and backpack in one portable set-up. Streamline your gear.

FULL RUT

The whitetail, treestand hunter's gear solution in a backpack. Carry your rattling antlers and all of your gear in silent, organized pack set-up.

PASSTHROUGH 2

Simply put, the best organization option in soft-sided bow storage. 'Maxed-out' pocket storage for everything from rangefinders... to release aids. Maximum protection for your Mathews®.

BACKTRACK

All of the features of a backpack - with the protection of a padded case. *Includes (1 pc) PackStrap Accessory, to attach any brand of quiver. -600-D POLYESTER fabric.





**MATHEWS® LOGO
ALL WEATHER BOW CASE**
98112

- Fits most Mathews® bows including the Z7 and Z7 Extreme
- Rugged, textured exterior
- Crush-resistant PillarLock® System
- Airline approved
- Air, water & dust resistant seal
- 48" L x 7.5" W x 20.75" H

**MATHEWS® LOGO
BOW CASE**
1144-60

- Fits all Mathews® bows
- Adjustable PillarLock® System allows for storage of multiple bow configurations
- Four Tight sealing cam action latches
- Weather Resistant Foam Gasket keeps dust and moisture outside the case
- Includes 1309 Utility Box
- 48" L x 7.5" W x 20.75" H



**PILLARLOCK™ SERIES
ARROW CASES**

- Crush-resistant PillarLock® System
- Holds up to 18 arrows
- Sur-Lok™ arrow holders securely store arrows
- Comfortable molded-in handle
- 36" L x 10.75" W x 4" H

MISSION® LOGO 1118-65



**MATHEWS® LOGO
COMPACT ARROW CASE**
1127-60

- Holds up to 28 arrows
- Includes broadhead and accessory boxes
- Fits in front pocket of 93842 Soft Bow Cases
- 36.375" L x 7.5" W x 3.1875" H



MATHEWS® LOGO 1118-60



**MATHEWS® LOGO
SPORTSMAN'S TRUNK**
1819-60

- Ideal for storing large hunting gear
- Tie-down brackets on each end
- Molded grooves for sturdy stacking
- Lockable/ Airline approved
- Recessed handles
- 38.25" L x 21.75" W x 18.5" H



**MISSION® LOGO
PILLARLOCK™ BOW CASE**
1110-65

- Fits Most Mission® Bows including the Craze®
- Crush-resistant PillarLock® System
- Comfortable molded handle
- Padlock tabs
- Arrow storage under lid
- High-density foam padding
- 43.25" L x 6.75" W x 19" H



**MISSION® LOGO
SOFT BOW CASE**
93840

- Fits most Mission® bows including the Craze®
- Large front pocket holds 1127 Compact Arrow Case
- High density foam padding
- 37" L x 7" W x 19" H



**GENESIS® LOGO
PILLARLOCK™ BOW CASE**
1109-60

- Fits Genesis®, Mission® Craze® and Menace® bows
- Crush-resistant PillarLock® System
- Comfortable molded handle
- Padlock tabs
- Arrow storage under lid
- High-density foam padding
- 41" L x 4.75" W x 15" H



**GENESIS® LOGO
SOFT BOW CASE**
83360

- Fits Genesis® bows
- 40" L x 1.5" W x 14" H



**MATHEWS® LOGO
COMPACT
BROADHEAD BOX**
1311-60

- Holds both fixed blade and expandable broadheads
- Lift-out accessory tray
- 6.75" L x 5" W x 5" H



**MATHEWS® LOGO
ARCHERY
ACCESSORY BOX**
1348-60

- Holds both fixed blade and expandable broadheads
- Lift-out accessory tray
- See-through lid
- 11.5" L x 8.25" W x 5" H



**MATHEWS® LOGO
SLIM ARCHERY
ACCESSORY BOX**
1348-60

- Adjustable storage compartments
- Broadhead retainer and tool
- Slim size for easy packing
- 12.5" L x 7.5" W x 1.75" H





HUNTER XL SERIES BOW CASE
2SKB-4120M

HUNTER SERIES BOW CASE
2SKB-4117M

- XL interior dimensions 41" x 17" x 5"
- Small interior dimensions 39" x 15" x 5"
- Plush EPS interior
- Foam arrow system
- Lockable draw-bolt latches
- 5-Year Limited Warranty

**MATHEWS® LOGO
LARGE HYBRID BOW CASE**
2SKB-SC4120M

**MATHEWS® LOGO
SMALL HYBRID BOW CASE**
2SKB-SC4117M

- Large interior 41" x 17" x 5"
- Small interior 39" x 15" x 5"
- Rugged 600 Denier ballistic nylon
- Black with Lost Camo® edition accessory pocket
- Rigid EPS interior; ultra-light
- One Year Limited Warranty



**MATHEWS® LOGO
TARGET/LONG BOW CASE**
3i-5014-MPL

- Interior dimensions 48" x 14.5" x 6"
- MIL-STD injection molded watertight ATA case
- Wheels and stainless steel locking loops
- Trigger release latches, TSA locks available
- Holds a dozen arrows
- Lifetime Warranty and \$1500 Content Coverage



MATHEWS® LOGO SMALL BOW CASES - PINK
3i-3614-MPL-P

MATHEWS® LOGO SMALL BOW CASE - TAN
3i-3614-MH-T

- Interior dimensions 35" x 14" x 5"
 - MIL-STD injection molded watertight ATA case
 - Wheels and stainless steel locking loops
 - Trigger release latches
 - Holds a dozen arrows
 - Lifetime Warranty and \$1500 Content Coverage
- * Camo Wrap accessories available 2-MCW-34, 2-MCW-44, 2-MCW-47 and 2-MCW-54



**MATHEWS® LOGO
PARALLEL LIMB
BOW CASE**
3i-4214-MPL

**MATHEWS® LOGO
PARALLEL LIMB
BOW CASE - TAN**
3i-4214-MPL-T

- Interior dimensions 39" x 13.5" x 6"
- MIL-STD injection molded watertight ATA case
- Wheels and stainless steel locking loops
- Trigger release latches
- Holds a dozen arrows
- Lifetime Warranty and \$1500 Content Coverage



**ULTIMATE WATERTIGHT
BOW CASE**
3i-4217-MPL

**ULTIMATE WATERTIGHT
BOW CASE - TAN**
3i-4217-MPL-T

- Plush lined interior 41" x 15.5" x 5"
- MIL-STD injection molded watertight ATA case
- Wheels and stainless steel locking loops
- Trigger release latches, TSA locks available
- Holds a dozen arrows
- Lifetime Warranty and \$1500 Content Coverage
- 3i-4217-MDB and 3i-4217-MDB-T Double Bow
- Interior also available w/bunk bed divider



October Mountain Products

OMP's licensed bow cases are designed specifically to cradle your Mathews® or Mission® bow. Feature rich and constructed from rugged 600-Denier materials. New for 2014, an all-new 3-tube, reversible Mission® Logo Hip Quiver.

MISSION® LOGO 3 TUBE REVERSIBLE HIP QUIVER

61145

Black/Lost Camo® AT



MISSION® CRAZE® LOGO 36" COMPOUND BOW CASE

60888

Black/Lost Camo® AT



MATHEWS® LOGO 41" CUSTOM COMPOUND BOW CASE

60892

Black/Lost Camo®



MISSION® LOGO 41" COMPOUND BOW CASE

60889

Black/Lost Camo® AT

CASES / PACKS



PREPARATION AND PLANNING FOR THE HUNT, AND NOW THE MOMENT OF TRUTH



LOSTCAMO.COM



BOWCASES



DELUXE 4715

Seven generously sized interior and exterior pockets for complete storage of bows, arrows, accessories, and range gear. Compatible with all Easton arrow tote and arrow case models. Premium oversized #10 zippers with easy grab pulls. Cavemous 3.5" case-cube compatible fleece-lined padded interior (Case Cubes sold separately) Fits most bows—interior dimensions 44" x 16". 360° padding for complete bow protection. Movable bow-anchoring straps for rock-solid bow security.

GENESIS® LOGO

Custom tailored for the Genesis® compound bow. Rugged high-denier POLY construction with thick interior padding. Premium zippers with easy-grab pulls. Integrated Easton arrow-tote attachment straps. Exterior mesh accessory pocket.



FLATLINE

Sleeve-style bow case for maximum protection and space saving compact size. Compatible with all Easton arrow tote and arrow case models. Premium oversized #10 zippers with easy grab pulls. Fits most bows and arrow cases; interior dimensions of 43" x 16". Two exterior and one interior accessory pockets for release aids, rangefinders, tools or other archery essentials.

MICRO FLATLINE

Designed for maximum protection and space saving compact size. Rugged high-denier POLY construction with thick interior padding. Premium zippers with easy grab pulls. Fits most bows; interior dimensions of 35" x 16". Exterior mesh accessory pocket.





D.R.T. - DEAD RIGHT THERE!

- Lost Camo® Edition!
- 1 13/16" Total Cutting Surface!
- 1 3/16" Blade, 5/8" Bleeder!
- Teflon Coated!
- Lifetime Guarantee

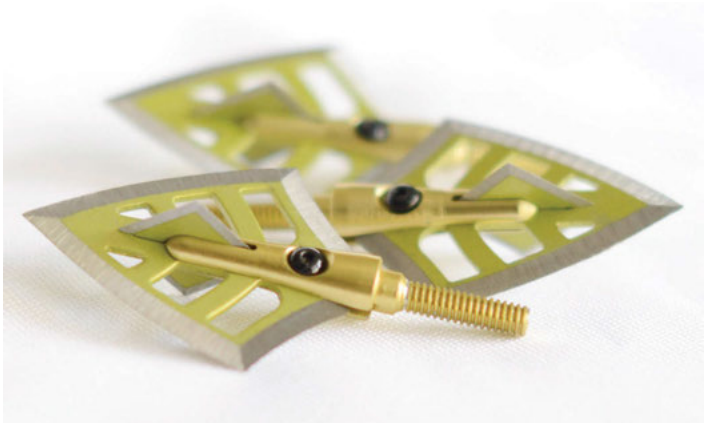

FLYING ARROW ARCHERY

Flying Arrow Archery revolutionized the broadhead industry in 2013 with its unique accurate blade design. The coring design of the Toxic broadhead has given bow hunters around the world the results they crave with its accuracy, wound channel and successful harvest rate. The Toxic comes standard with open-flex technology and a single beveled edge. This technology is accompanied by a bone crushing chisel tip that allows the broadhead to penetrate exceptionally well.

With the wonderful success and buzz created by the Toxic last year, Flying Arrow Archery is now offering a Toxic driven design that is aimed at the more traditional archers. The new Cyclone broadhead is a more conventional style head but with the Flying Arrow twist, making it a happy medium between the lethal Toxic and the classic three blade design. Both broadhead designs are available in 100 gr, 125 gr., crossbow, Deep Six, and Vertical bow options.

TOM BOMB
125 GRAIN
Red TB125

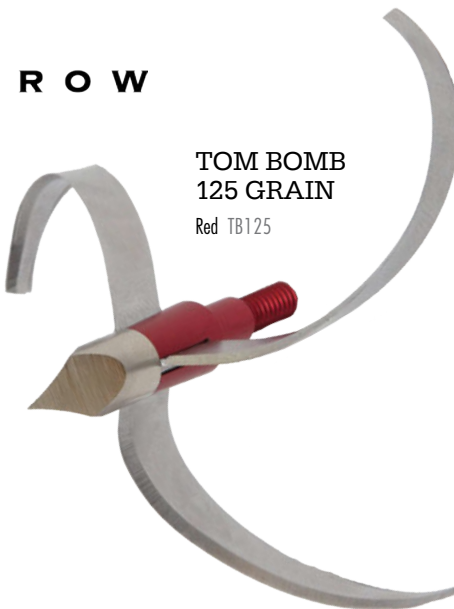

CYCLONE 100 GRAIN
Lost Camo® Edition C3100-M



TOXIC 100 GRAIN
Lost Camo® Edition T3100-M



MAXIMA RED

ULTIMATE HUNTING PERFORMANCE – REDEFINING BROADHEAD ACCURACY

The Mathews® Edition Maxima RED® with Lost Camo® RED ZONE® is designed to deliver the ultimate in broadhead and bowhunting performance. Mathews® testing shows that Maxima® arrows make Mathews® bows shoot best, and that Maxima RED® arrows deliver a breakthrough level of broadhead consistency and shooting performance. Managing how an arrow flexes in flight (Dynamic Spine) is the key to arrow accuracy, and no one does a better job at this than Carbon Express®. *Contain the enemy of accuracy - Mathews® Edition Maxima RED® with Lost Camo® RED ZONE® – the best hunting arrow ever.*

- 50744 Maxima RED® Mathews® Edition 250 – 12 Pack Shafts
- 50745 Maxima RED® Mathews® Edition 350 – 12 Pack Shafts
- 50740 Maxima RED® Mathews® Edition 250 – 6 Pack Arrows
- 50741 Maxima RED® Mathews® Edition 350 – 6 Pack Arrows
- 50742 Maxima RED® Mathews® Edition 250 – 36 Bulk Arrows
- 50743 Maxima RED® Mathews® Edition 350 – 36 Bulk Arrows



CARBON EXPRESS®



NEW

MAXIMA PNK[™] RZ

New Maxima® PNK™ RZ – THE ULTIMATE LIGHTWEIGHT HUNTING ARROW

The Maxima® PNK™ RZ sets a new standard for hunting arrow performance. It combines the same world class, lightweight speed and accuracy of the Maxima Blue Streak® with the breakthrough broadhead accuracy of the Maxima RED®. The result: a new, lightweight hunting arrow that shoots broadheads so well that it is a revolution in bow hunting performance. The PNK™ RZ features a hi-tech carbon shaft designed with stiffer ends that isolate the arrow's flex in the middle of the shaft: the RED ZONE®. Testing shows that the new PNK™ RZ with RED ZONE® technology flies broadheads as well as field points. The PNK™ RZ features pink accents that match the 2015 Mathews® Chill™ SDX PNK™ bow graphics package.

- 50799 Maxima PNK™ Mathews® Edition 150 – 12 Pack Shafts
- 50797 Maxima PNK™ Mathews® Edition 150 – 6 Pack Arrows
- 50798 Maxima PNK™ Mathews® Edition 150 – 36 Bulk Arrows

Shoot Safer: For instructions regarding safe use of arrows, go to safearrow.com.

Mathews®, Lost®, Chill™ and PNK™ are trademarks belonging to Mathews, Inc.



NITRO VANES (MATHESW® LOGO)

- Superior adhesion with "Micro Glue Pockets"
- Retains more energy downrange
- xtremely quiet in flight
- Available in 2.0" and 2.2" Low Profile



BROADHEADS

Ramcats are the hardest hitting, deepest penetrating, most accurate broadheads with the largest fixed blade cut diameter on earth. These are the only fixed blade Broadheads that will fly with your field points. The 100 and 125 grain Ramcats have cut diameters of 1 3/8" and 1 1/2", respectively, and blades are sharpened on the rear and have the ability to roll forward so they cut coming back out. 420 heat treated stainless steel body ferrule that has a Hydroshock Self-Centering Chisel Tip with patented deep lobes, .032" thick blades, and Firenock Aero Insert Technology. Hits like a Ram... Cuts like a Cat!



100 GRAIN RAMCAT BROADHEADS

100 GRAIN CROSSBOW
RAMCAT BROADHEADS



125 GRAIN RAMCAT BROADHEADS

125 GRAIN CROSSBOW
RAMCAT BROADHEADS



BLACK EAGLE



CARNIVORE

BLACK EAGLE ARROWS CARNIVORE, LOST CAMO® EDITION CRESTED ARROWS

The 19 series Carnivore is our premium 100% carbon hunting / 3-D shaft. It's flight characteristics were designed by experienced professional shooters to optimize speed, kinetic energy, and penetration for a wide range of environments. The Carnivores are each weight-sorted and spine-matched to offer the most consistent grouping. This shaft's exceptional durability and accuracy is sure to bring home the trophy deep in the woods or on the 3-D course.

Features

- .001" Shaft Straightness or Straighter
- ± 1 Grain Weight Tolerance
- 32" Shaft Length
- Fletched Arrows include, Black Bohning Double-Lock Nocks, Carnivore Inserts, Bohning Blazer Vanes
- Available in 250, 300, 350, 400 Spines



Arrow Model*	Spine/ Size	Grains Per Inch	Straightness Tolerance	Weight Tolerance
XT Hunter - Crested Lost Camo®	500	8.2	+/- .003	+/- 2 grains
XT Hunter - Crested Lost Camo®	400	9.0	+/- .003	+/- 2 grains
XT Hunter - Crested Lost Camo®	300	10.9	+/- .003	+/- 2 grains
Expedition Hunter - Crested Lost Camo®	500	8.2	+/- .006	+/- 2 grains
Expedition Hunter - Crested Lost Camo®	400	9.0	+/- .006	+/- 2 grains
Expedition Hunter - Crested Lost Camo®	300	10.9	+/- .006	+/- 2 grains

* Available in shafts or fletched with 2" Vanes
 * Includes GT Accu-Lite Inserts (12.1 gr) & GT .246 Nocks (11.5 gr)

Gold Tip proudly offers its best-selling "Hunter" arrow in a Lost Camo® edition for the ultimate in concealment and performance. Fully decorated in Lost Camo®, Gold Tip's proprietary process results in the most durable camo arrow finish on the market, guaranteed shot after shot regardless of target type!

Available in XT Hunter & Expedition Hunter models.





THE VICTORY TRIFECTA

THE CHOICE OF SERIOUS ARCHERS



THE CARBON ARROW EXPERTS



.166
.204
.245



ARROWS

BEMAN ICS HUNTER PRO LOST CAMO® EDITION ARROWS

Get the hot look of Lost Camo® and the flat-shooting speed of Beman's most advanced lightweight camo carbon. The ICS Hunter Pro Lost Camo® edition comes equipped with the Microlite™ S Nocks and point inserts - giving bowhunters a flat, accurate trajectory and hard-hitting downrange impact.

BEMAN
FIRST IN CARBON ARROWS®

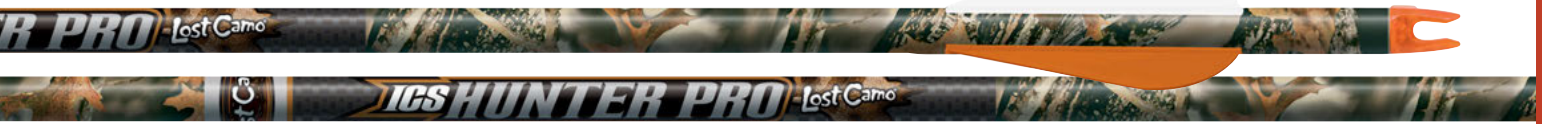

EASTON FULL METAL JACKET LOST CAMO® EDITION ARROWS

Get the awesome performance of the heavy hitting X-diameter FMJ in Lost Camo®. Features a micro diameter carbon core wrapped in an aerospace alloy metal jacket for magnum big-game stopping power.

EASTON

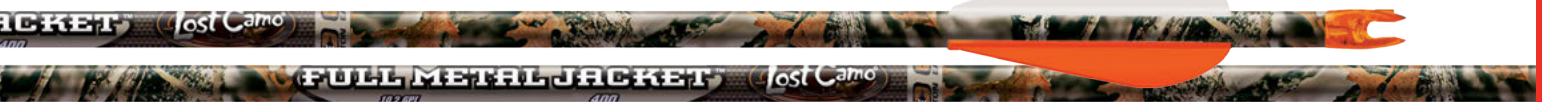

QUIVERS

FLIPSIDE™ HIP QUIVERS

Innovative design fits both right and left-hand shooters - for wear on either side. Rugged high-denier POLY construction. Stainless steel belt clip attachment. Durable injection-molded arrow separator tubes. 2-tube, 3-tube, and 4-tube designs.





ALPINE SOFT LOC QUIVER

- Patented rubber mount reduces vibration, noise and recoil
- Silent, quick detach mount and full vertical adjustment
- Available in 3, 5 and 7 arrow versions
- Accepts all common arrow sizes
- Works great with standard or mechanical broadheads
- Made in the USA

ALPINE BEAR CLAW QUIVER

- Rugged, lightweight, and affordable
- Works great with vertical bows and crossbows
- Solid, rattle free latch mounts up fast and easy
- 8" of vertical adjustment
- Available in 3 or 5 arrow versions
- Accepts all common arrow sizes
- Works great with standard or mechanical broadheads
- Made in the USA

ALPINE POWER LOC ULTRA LITE QUIVER

- Mass weight only 6.5 ounces!
- Overall length 11.5" with full vertical adjustment
- Patented rubber mount reduces vibration, noise and recoil
- Machined aluminum mounting base and quick detach lever
- Works great with vertical bows and crossbows
- Available in a 4 arrow version and accepts all common arrow sizes
- Works with standard or mechanical broadheads
- Made in the USA



TREELIMB QUIVERS

PREMIUM SERIES QUIVERS
STANDARD SERIES QUIVERS

- Both models available in 3 and 5 arrow capacity
- 100% made in the USA



STANDARD SERIES

PREMIUM SERIES



QUIVER

The Ramcat quiver is specially designed to hold the large cut diameters of the 100 and 125 grain Ramcats. The quiver is a Treelimb quiver that holds 5 arrows and has a double gripper system. Available in Lost Camo®, Lost Camo® AT, Black and Carbon fiber.



KWIKEE KWIVER

DURABLE, TOUGH, & AFFORDABLE!
All Kwikkee Kwiver® products come with an unconditional, lifetime warranty!



LOST CAMO® AT
EDITION
Secures 3 arrows



LOST CAMO® AT
EDITION
Secures 4 arrows



LOST CAMO®
EDITION
Secures 4 arrows

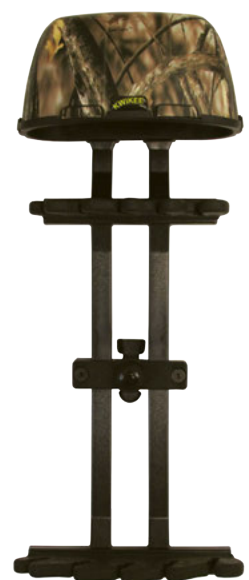

LOST CAMO®
EDITION
Secures 5 arrows

QUIVERS

LIMBSAVER® By SVL SIMS VIBRATION LABORATORY

SILENT QUIVER

- Hood is made out of a durable and flexible material for absolute silence
- Innovative quick detach mechanism
- Securely holds 5 arrows sized 0.240" - 0.360"



ELEVATION™

MATHEWS® LOGO TRANSITION™ HIP QUIVER

Our Mathews® Logo Transition Hip Quiver features our Comfort-Tec technology offering a comfortable, durable and balanced feel. It also sports a large, embroidered Mathews® logo and bold accents. Multiple compartments round this hip quiver out giving you ample room for everything you'll need on the range.



- Comfort-Tec Padding
- Heavy-duty Zippers
- Vented Pockets
- Accessory Sleeves
- Dual Belt Clips
- D-Ring
- 2" Belt Receiver
- Scorecard Sleeve
- Pen Sleeve
- Kickstand Sleeve





TightSpot™

The quiver that fits tight to your bow

3-ARROW QUIVER

- Fits tight and is so light you won't even notice it's on your bow
- Quick Draw arrow system puts your arrow close at hand for a second shot
- Compact design is ideal for treestand's tight quarters
- Super quiet performance; ideal for close-in shots
- Acts as a stabilizer for more accurate shooting
- Three arrows are plenty for virtually any treestand hunt
- Holds arrows tight eliminating lost or dropped arrows



5-ARROW QUIVER

- New Acoustic Dampening Material makes it quiet
- Better bow balance
- Dramatically reduce torque
- Kills vibration 4 ways
- 20x more arrow gripping power
- No more dull broadheads or accidentally deployed expandables
- Rubber hood outlasts foam 10 to 1
- Also available in Black Tactical, Desert Tactical, Black Crimson and more
- Made in the USA



Axion archery accessories are perfect to complete your Mathews® bow set-up.

RACK
4 ARROW QUIVER
9.0 oz

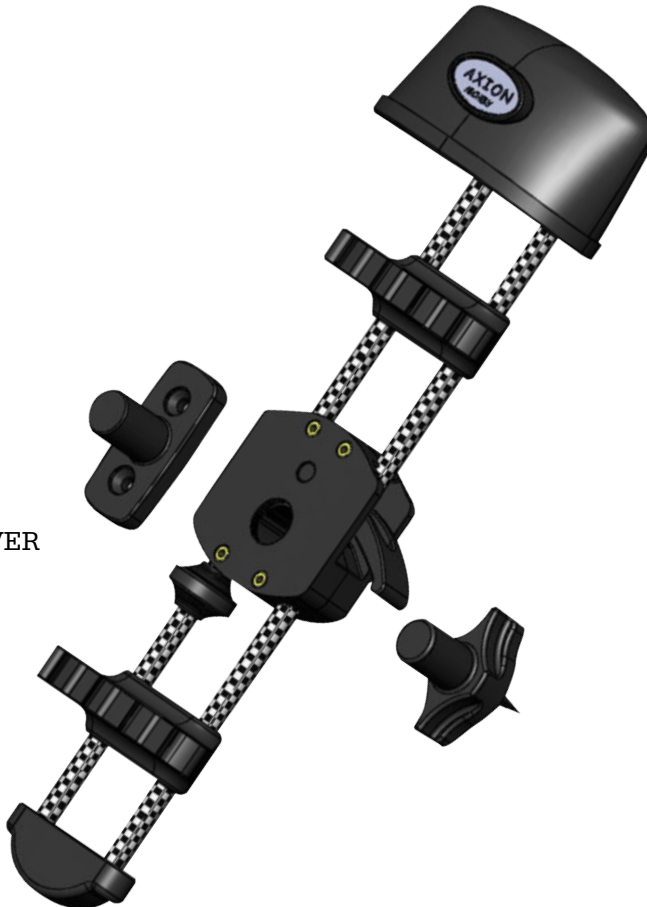

LIMBSAVER[®]

By SVL SIMS VIBRATION LABORATORY



LS HUNTER

- Carbon fiber frame is packed with vibration dampening technology
- Removable weighted Broadband node improves balance and neutralizes vibration
- Eliminates bow torque and hand shock

AWS MODULAR STABILIZER

- Skeletonized design for high vibration control
- Innovative sliding weight for fine tuning balance
- Threaded attachment point for additional nodes or accessories

STOKERIZED

Uncompromised Performance



LOST CAMO[®] EDITION / CARBON

SS1-HD

All the versatility and functionality that a side mounted stabilizer has to offer. The SS1-HD counter balances all unwanted torque induced from sights, rests, quivers, riser geometry and hand pressure.

- Bracket mount is adjustable up and down
- Carbon bar is adjustable front and back up to 3.5"
- Weight adjustable from 5 oz. - 10 oz. with Mathews[®] Harmonic Stabilizers™ options
- Incorporates Mathews[®] Harmonic Dampers™
- Measures 11.25" and weighs 11.5 oz.



LOST CAMO[®] EDITION / SMOKE

SS1

The SS1 is the original fully adjustable side mounted stabilizer. Perfectly balances and isolates your bow of unwanted torque in a compact, ultra adjustable, fully weight adjustable system.

SS1 G2 8.5 measures 8.5" and weighs 8 oz.
SS1 G2 10.5 measures 10.5" and weighs 8.5 oz.



LOST CAMO[®] EDITION / CARBON

LOST CAMO[®] EDITION

STASIS

The Stasis is a progressive design of our top selling SS1 off-set stabilizer. The only stabilizing bar on the market with a built-in ALL AXIS PIVOT point. This patent pending ALL AXIS PIVOT point in conjunction with our patent pending SS1 bracket design allows for infinite adjustments to counter balance your bow.

Available in 15" and 19" lengths and comes standard with SS1 bracket and six 1 oz. stainless steel weights in your choice of black or Lost Camo[®].



LOST CAMO[®] EDITION / CARBON

HD9

The HD-9 is the only high modular carbon stabilizer incorporating Mathews[®] Harmonic Dampers™. The HD-9 is 100% American Made. Perfect for archers looking for the added stability of a slightly longer front bar without compromising maximum maneuverability.

HD-9 measures 9" and weighs 6.5 oz.



8" LOST CAMO[®] EDITION / SMOKE

HUNTER G2 STABILIZER

Hunter G2 stabilizers feature our patented acrylic rod technology eliminating shock, vibration and noise. Designed slightly lighter making them perfect for a lighter set-up but will also accommodate a heavier set-up with the ability to add unlimited weight.



LOST CAMO[®] EDITION

HD2 & HD3

The HD2 and HD3 compact stabilizers incorporate Mathews[®] Harmonic Dampers™ and Mathews[®] Harmonic Stabilizers™ to produce an effective weight adjustable stabilizer option. The precision American made 6061 aluminum body of the HD2 and HD3 houses several dampers in a smaller area producing greater vibration reduction.

HD2 measures 4.25" and weighs 5.25 oz.
HD3 measures 6" and weighs 7 oz.



LOST CAMO[®] AT EDITION





Axion archery accessories are perfect to complete your Mathews® bow set-up.



5 INCH LOST CAMO® OT EDITION



**CLOUD
STABILIZER**
Available in 5 inch, 7 inch and 9 inch

7 INCH LOST CAMO® OT EDITION



5 INCH LOST CAMO® EDITION



5 INCH LOST CAMO® OT EDITION



3 INCH LOST CAMO® OT EDITION



5 INCH LOST CAMO® EDITION

**GLZ
STABILIZER**
Available in 3 inch and 5 inch.



3 INCH LOST CAMO® EDITION



Z STICK STABILIZER
6 oz



SHIFT SINGLE PIN ADJUSTABLE SIGHT
7.5 oz Black



2N1 HTR STABILIZER
7.0 oz Lost Camo® OT



INFINITY 7
Stabilizer
• Uses Mathews® Harmonic Dampers™ and Mathews® Harmonic Stabilizers™



MK9-SB
Front Mount Offset Sidebar with Quick Disconnect



TECH 5
Gridlock Stabilizer
• Uses Mathews® Harmonic Stabilizers™

NITRO HUNTER STABILIZER

- Great Bow Balancer
- Destroys Vibration
- Great Look
- Includes "Sawtooth" Vibration Dampening Technology
- Available in 5.5" (5 oz) and 7.5" (6 oz) versions.





X-Factor Outdoor products Lost Camo® edition



NEW
FOR 2015

X-FACTOR XTREME STABILIZER

This is not just another pretty Stabilizer! X-Factor patented shock block technology combined with Mathews® Harmonic Stabilizer™ or Mathews® Harmonic Stabilizer™ Lite make for an Amazing Combination!

- Superior sound and vibration dampening!
- Your choice of Mathews® Harmonic Stabilizer™ or Mathews® Harmonic Stabilizer™ Lite!
- Your choice of color available in Lost Camo®, Lost Camo® AT, Carbon, Black, or Red.
- You can also mix and match color combinations to match your bow!
- You have to try this stabilizer and experience the X-Factor difference for yourself!

6" light weighs 8.5 oz. and 6" heavy weighs 10.5 oz.
8" light weighs 10.5 oz. and 8" heavy weighs 12.5 oz.

6 INCH XTREME STABILIZER

Weights 8.5 oz. and 10.5 oz.



8 INCH XTREME STABILIZER

Weights 10.5 oz. and 12.5 oz.



HUNTING STABILIZERS LOST CAMO® EDITION

Aluminum end caps, carbon rod and large rubber shock. Designed to improve your shot and steady your bow. Three lengths to choose from. 5/16 x 24 threads. 6.5", 8.5" OR 11.5"



SINGLE & DOUBLE ADJUSTABLE V-BAR LOST CAMO® EDITION

Solid locking fully adjustable single offset bar with an integrated disconnect that allows full rotation of the side bar. These offset bars are designed to support any stabilizer weight.



DISCONNECTS. STRAIGHT, EIGHT & TWENTY DEGREES LOST CAMO® EDITION

Stabilizer disconnects allow rapid installation and removal of your stabilizer without risk of damage to your riser threads. Three angles are available and they feature a hex to make lining them up easier. 5/16 x 24 threads.



SWIVEL DISCONNECT W/ SLING LOST CAMO® EDITION

The swivel disconnects allows a shooter to rotate their stabilizer up and out of the way for easy storage in a bow case. Instead of taking it off - just fold it up! Comes with Camo Sling and barrel nut.



GRIPS LOST CAMO® EDITION

Replacement grips for Mathews® Adult Bows with a wooden factory handle. These grips provide a flat consistent surface for your hand and help reduce torque. Offered in Standard and a Low profile.



TRAILER HITCH COVERS

Built to last with all Anodized Aluminum. Designed to fit standard 2" receivers.

- Gold with Lost Camo® Face
- Black with Lost Camo® Face
- Gold with Diamond Plate Face



Stabilizer Model	Length (Bar Only)	Weight (Bar Only)	Included Weight(s)	Total Weight	Total Length Incl. (3) Weights
Sport Hunter Xtreme - Lost Camo®	6"	3.72 oz*	(3) 1 oz	6.72 oz	6.50"
Sport Hunter Xtreme - Lost Camo®	8"	4.00 oz*	(3) 1 oz	7.00 oz	8.50"
Sport Hunter Xtreme - Lost Camo®	10"	4.28 oz*	(3) 1 oz	7.28 oz	10.50"
Pro Hunter Maxx - Lost Camo®**	8"	4.00 oz*	(2) 4 oz & (1) 2 oz	14.00 oz	8.574"
Pro Hunter Maxx - Lost Camo®**	10"	4.28 oz*	(2) 4 oz & (1) 2 oz	14.28 oz	10.574"
Pro Hunter Maxx - Lost Camo®**	12"	4.56 oz*	(2) 4 oz & (1) 2 oz	14.56 oz	12.574"

* Includes De-resonator
 ** Fully adjustable in 2 oz / 4 oz / 6 oz / 8 oz or 10 oz weight configurations

SPORT HUNTER XTREME

Bee Stinger's Sport Hunter Xtreme Stabilizer is specifically engineered to maximize a bow's moment of inertia to improve aiming and reduce bow torque throughout the shot. The ultra-rigid 100% carbon bar coupled with three adjustable end weights allow fine-tuning in 1 ounce increments optimizing perfect bow balance and stabilization.



PRO HUNTER MAXX

Bee Stinger's Pro Hunter MAXX Stabilizer incorporates a unique, patented and fully customizable end weight system designed to maximize a bow's moment of inertia to improve aiming and reduce bow torque throughout the shot. The ultra-rigid 100% carbon bar coupled with three large diameter, focused end weights allow configurations of 2, 4, 6, 8 or 10 ounces for the ULTIMATE in accuracy-enhancing bow balance and stabilization.



LC 360 REST



LC APACHE REST



LC APACHE 5 STABILIZER



LC APACHE 8 STABILIZER





ULTRA-REST HDX

- Total containment
- Total fletching clearance
- Drops only when the bow is fired not during a slow let-down
- No bounce back
- Tested at over 400fps
- Deadly silent draw
- Made in the U.S.A with a Limited Life Time Warranty



CODE RED

Bowhunter's #1 selling fall-away rest!
The Ripcord® Code Red is proven and dependable. Code Red falls fast! That's why it's the #1 choice of so many bowhunters! Fast fall-away minimizes time hand torque can be transferred to the arrow.

- Ultra-fast fall-away for maximum forgiveness
- Soft overmolding eliminates the need for extra moleskin
- Innovative Drop Dead Brake System™ keeps launcher from bouncing back up into the arrow as it leaves your bow
- Arrow Containment System™ assures your arrow can't fall off the rest
- Exclusive "football clip" fits all cable sizes making the Code Red easy to install



ACE

The new Ripcord® ACE™ represents a quantum leap in fall-away rest design thanks to hundreds of hours of testing using high-speed camera footage. ACE is also the first micro-adjustable fall-away rest to offer micro-adjustability and a "narrow" hunting launcher. Micro-adjustability allows you to fine-tune rest position like never before. You won't believe how well you will shoot! The narrow hunting launcher is an innovation that dramatically increases vane clearance.

- FireFall Design™. The launcher falls only when you fire, not when you let down
- Fulltime Arrow Containment
- DoubleDown Brake™ ensures there is no launcher bounceback!
- Outboard Cord™ fully external cord. This completely eliminates any cord wear issues and positions the cord well to the side of the arrow
- RightTime™ Fall Away System eliminates the transfer of your bow hand torque to the arrow. Yet the launcher also offers stability to the arrow upon release



SMACKDOWN PRO ARROW REST

Trophy Taker's popular SmackDown PRO arrow rest now features an integrated Mathews® Harmonic Dampener™ in the mounting bar.

- Full capture
- Silent coated containment ring with easy load gate
- Limb or cable driven
- Multiple spring tension settings
- All metal construction
- Sleek, lightweight and quiet

BLACK GOLD

Premium Bowsights



BACKDRAFT

BackDraft™ will blow you away with innovation and performance!

- High-performance PhotoChromatic shell
- Floating pin bushings for smooth, easy fine-tuning of sight pins
- Oversized second axis adjustable level is easier to see, easier to set
- Wide Delrin™ Hush Wheels for smooth adjustment and quiet operation!
- Gang horizontal and vertical calibrated adjustment
- Inch Wheel micro-adjustable pins
- 2X or 4X lens adaptable (optional) makes targets easier to see
- Interchangeable fluorescent guard ring



RUSH

The RUSH™ gives you Black Gold® innovation and durability

- Large adjustable level is easy to see
- High performance PhotoChromatic technology
- Available in 3-7 sight pins
- Interchangeable fluorescent sight ring for quick and positive peep alignment even in low light
- Optional BigDog™ pin guard for use with oversized peeps
- Lens Kit adaptable (1 3/4" guard only)
- Built tough, light-weight and perfect for any Mathews® bow





**BUCKHEAD® ELITE
5 PIN TOOLLESS
LOST CAMO® EDITION**

- NO TOOLS windage and elevation are available on some selected models
- Unique reversible mounting bracket
- Available in 3, 5 or 7 protected all-metal .019" fiber optics
- Universal design for right and left hand shooters
- Featuring Mathews® Harmonic Damper™ Technology
- 2" aperture with bright white ring for quick target acquisition
Includes rheostat light designed and mounted to prevent haloing
- Adjustable 3rd axis bubble level



**BUSHWHACKER W/ LIGHT
LOST CAMO® EDITION**

- Reversible mounting bracket with offset mounting holes provides a wide range of vertical adjustment
- Easily adjusts for windage and elevation
- 4 protected .019" metal pins
- Rheostat light available
- All-metal design
- 1.75" aperture with bright white ring for quick target acquisition
- Adjustable 3rd axis bubble level
- Also available in Lost Camo® AT



**SMOKE 5 PIN W/ LIGHT
LOST CAMO® EDITION**

- Lightweight design is only 4.8oz.
- Easily adjusts for windage and elevation
- 5 protected .019" all-metal fiber optic pins
- Incredible fiber optic pin brightness
- 2.2" round composite sight guard with glo-orange ring for quick target acquisition
- Built-in bubble level



**SMOKE G2 5 PIN W/ LIGHT
LOST CAMO® AT EDITION**

- Lightweight Design
- Reversible mounting bracket with offset mounting holes provides a wide range of vertical adjustment
- Easily adjusts for windage and elevation
- 2" aperture with glo-orangering for quick target acquisition
- Adjustable 3rd axis bubble level
- Also available in Lost Camo®



MARK III

The Mark III is the pinnacle of durability and design with an all-aluminum construction combined with bright, rugged pins and an optional micro adjust and dovetail mount. Includes a light and hardware.



MARK III MICRO

Outfit your bow with a durable and reliable Copper John Mark III Micro five pin Sight. This sight features an all-aluminum construction, RH/LH convertible, professional dovetail add-on option and ultra bright fibers with durable pins.



MARK IV

The Mark IV Slider sight matches quality and design in this all-aluminum, smooth operating sight. With an optional micro adjust kit and, glow in the dark sight tape and level, this sight delivers.



RUT WRECKER

Featuring Lost Camo®, the Rut Wrecker offers superior value at a price you can afford.

- All-Aluminum pins
- Wrapped fiber for extra bright pins
- Reinforced chassis for durability
- RH/LH adaptable



OPTIMIZER LITE KING PIN

20 years in the making, the 3rd generation of archery's #1 selling, single pin mover is loaded with features no other bow sight can offer. Interchangeable wheels make changing tapes easier than ever before and allow for using multiple arrow and draw weights. A crystal clear magnifier and Blue Burst light allow for rapid adjustment in the darkest of blinds and for the oldest of eyes. Fully integrated 2nd and 3rd axis adjustment top it all off to make this the most accurate and deadly hunting sight on the market today. On the range or in the field, start ruling your kingdom today with the Optimizer Lite King Pin.

- Industry's most accurate sight tape system. Sight in at 20 and 60 yards and you're dialed in TO THE YARD out to 100
- Wheel-forward design is ideal for mounting one-piece quivers
- Sight tape magnifier allows for adjustment to the 1/4 yard!
- Optional Blue Burst light (model 2500) illuminates sight tapes for rapid adjustment in dark ground blinds
- "Blind 20" feature allows for fast, no look return to your most common predetermined distance
- 2.1" of vertical travel adjustment
- Precision machined brass rack and pinion delivers silky smooth operation

2015 also marks the first time that an HHA sight is available on a dovetail!



SIGHTS / STABILIZERS / RESTS



VENOM XL

- Dovetail and fixed plate design, both with or without micro click-adjustment
- Large 2" Housing to work with large peep sights
- All Metal Razor Pins Available in .010, .019
- Available in price ranges for every budget

DIAMONDBACK

- Aggressive CNC machining matches Mathews® Bows
- Mathews® Harmonic Damper™
- Razor edge Pins
- 6" Dovetail Extension w/3rd axis



VENOM XL FIXED PLATE

VENOM XL DOVETAIL



DIAMONDBACK DOVETAIL



SX HUNTER STABILIZERS

- Strong and lightweight 6061 aircraft grade aluminum Construction
- 2" Stainless front stud for superior weight stacking flexibility
- Shock absorption
- Available in Three Lengths
 - 6" - 4.65 oz.
 - 8" - 4.8 oz.
 - 10" - 5.0 oz.

DIAMONDBACK FIXED PLATE





TRUGLO®

WHEN BRIGHTNESS COUNTS™



**RIVAL FX 5-PIN SIGHT
LOST CAMO® EDITION**
TG5915L

- Change fiber color without changing pins!
- TRU•FLO 3.0™ interchangeable fiber design allows for quick and easy fiber replacement (patent pending)
- TRU•TOUCH™ soft-feel technical coating
- Micro push-button light
- Micro-adjustable / Tool-less design
- Adjustable 2nd and 3rd axis level with two vertical bars
- Aperture has 2.0" inner diameter
- CNC-machined lightweight design



**RIVAL HUNTER 5-PIN SIGHT
LOST CAMO® EDITION**
TG5605L

ALSO AVAILABLE IN 3-PIN TG6502L

- Patented Decreasing Diameter Pin Design uses smaller pin sizes for longer yardages - see more of your target
- TRU•TOUCH™ soft-feel technical coating
- Ultra-fine click adjustment for windage and elevation
- Micro push-button light
- Adjustable 2nd and 3rd axis level with two vertical bars
- Aperture has a 1.8" inner diameter



**CARBON XS
4-PIN SIGHT
LOST CAMO® AT EDITION**
TG5704F

ALSO AVAILABLE IN LOST CAMO® TG5704L

- Ultra-lightweight carbon-composite construction
- TRU•TOUCH™ soft-feel technical coating
- Micro push-button light
- TRU•FLO™ fiber design
- Extra, extra long fully-protected fibers
- Large circular field of view
- Aperture has 1.8" inner diameter
- Reversible bracket for greater vertical adjustability
- Glow-in-the-dark shooter's ring helps align peep sight



**ARCHER'S CHOICE RANGE
ROVER MICRO SIGHT
LOST CAMO® EDITION**
TG6311L

- Our brightest 1-pin archery sight
- Tool-less yardage lock
- Extra long, fully protected wrapped fiber
- Ultra-smooth bracket for easy one-hand adjustment
- Sight housing accepts 1.87" scope lens (sold separately)
- Includes over 40 pre-marked yardage tapes to simplify setup
- Quiver can be mounted directly to bracket
- Rheostat light included



**DOWN-DRAFT
ARROW REST
LOST CAMO® EDITION**
TG630L

- High-performance drop-away design
- Quick and easy installation - no bow press required
- Sealed bushings increase downward speed at launch
- Technical rubber dampeners silence arrow loading
- Attaches to downward-moving buss cable
- For left and right-handed bows



**TRU-TEC CARBON PRO
6" STABILIZER
LOST CAMO® EDITION**
TG855L

ALSO AVAILABLE IN 8" LOST CAMO® TG850L

- HIGH-MODULUS carbon-fiber rod for superior strength
- CARBON-COMPOSITE exoskeleton
- TRI-FOIL shape for optimal rigidity
- Vibration dampening adjustable weight suspension system (Includes 3 stainless steel 1 oz. weights)
- Performance-based composites for vibration / noise reduction
- Improves bow balance and stability
- Weight is adjustable from 5 to 8 oz



**CARBON XS
5-ARROW QUIVER
LOST CAMO® AT EDITION**
TG335F

ALSO AVAILABLE IN LOST CAMO® TG335L

- POSITIVE•CAM•LOCK mounting system for smooth one-hand removal - moves the quiver tight against the bow riser for superior balance
- Vibration-free
- TRU•TOUCH™ soft-feel technical coating
- Secure double-gripper design
- Fits both mechanical and fixed broadheads
- Includes hanging loop for treestands or ground blinds
- Mounting bracket is adjustable to fit all bows
- Rubber hood insert reduces noise and won't dull broadheads
- Fits both left and right-handed bows



**LOC-DWN
4-ARROW QUIVER
LOST CAMO® AT EDITION**
TG324F

ALSO AVAILABLE IN LOST CAMO® TG324C

- Vibration-free
- TRU•TOUCH™ soft-feel technical coating
- Secure double-gripper design
- Fits both mechanical and fixed broadheads
- TWIST•LOCK mounting bracket quick / easy, one hand removal (patent pending)
- Mounting bracket is adjustable up / down to better fit all bows
- Rubber hood insert reduces noise and won't dull broadheads
- Fits both left and right-handed bows

APLEX GEAR



**ACCU-STRIKE PRO
5-PIN SIGHT
LOST CAMO® EDITION**
AG1515L

- TRU•ZERO™ pin design minimizes pin gaps
- Toolless design
- Lightweight / compact design (weighs 5.8 ounces)
- TRU•FLO™ fiber design
- Extra-long fibers
- TRU•TOUCH™ soft-feel technical coating
- Micro push-button light included.
- Aperture has 1.8" inner diameter



**ATTITUDE
5-PIN SIGHT
LOST CAMO® EDITION**
AG4815L

- Micro-adjustable windage / elevation
- GRAVITY•LINETM rotational adjustment aligns pin movement with gravity
- PRO•BRITETM PIN TECHNOLOGY that minimizes pin gap and maximizes pin brightness
- TRU•TOUCH™ soft-feel technical coating
- Adjustable 2nd and 3rd axis level
- Adjustable micro push-button light included



**TUNDRA
3-PIN SIGHT
LOST CAMO® AT EDITION**
AG1203F

- Ultra lightweight / compact design
- Ultra-tough composite construction
- TRU•TOUCH™ soft-feel technical coating
- Innovative pin design improves sight picture and protects fibers
- Aperture has 1.8" inner diameter
- Adjustable light included



**GAMECHANGER
5-ARROW QUIVER
LOST CAMO® EDITION**
AG225C

- "In-Out" adjustable mounting bracket moves the quiver tight against the bow riser to reduce torque and provides superior balance
- Easy one-hand removal
- Full adjustability allows quiver to mount behind the sight
- TRU•TOUCH™ soft-feel technical coating
- Secure double gripper design
- Fits both mechanical and fixed broadheads
- Technical rubber hood insert won't dull broadheads and reduces noise and vibration
- Fits both right and left-handed bows



**REACTOR
5-ARROW QUIVER
LOST CAMO® EDITION**
AG215L
ALSO AVAILABLE IN LOST® AT AG215F

- Low-profile design keeps quiver tight against the bow riser
- ISO•BRIDGE™ vibration dampener
- Easy one-hand removal
- TRU•TOUCH™ soft-feel technical coating
- Secure double gripper design
- Thumb tab style gripper design allows quick and quiet arrow removal
- Fits both mechanical and fixed broadheads
- Contrasting color rubber hood liner won't dull broadheads and facilitates arrow installation
- Fits both right and left-handed bows



**ACCU-STRIKE
4-ARROW QUIVER
LOST CAMO® AT EDITION**
AG204F
ALSO AVAILABLE IN LOST CAMO® AG2014L

- Vibration free
- Lightweight / compact
- TRU•TOUCH™ soft-feel technical coating
- Fits both carbon and aluminum arrows
- Secure, one-hand mounting bracket
- Fits both mechanical and fixed broadheads
- Technical rubber hood insert won't dull broadheads and reduces noise and vibration



**CARBON CORE
7" STABILIZER
LOST CAMO® EDITION**
AG828L

- High-modulus carbon-fiber core increases strength
- Carbon-composite exoskeleton reduces weight
- Rubber-isolated weighting system for maximum vibration dampening
- TRU•TOUCH™ soft-feel technical coating
- Interchangeable colored dampening rings
- Length is 7"
- Weight is adjustable from 6 to 8 oz.



**CARBON CORE
SIDE-BAR STABILIZER
LOST CAMO® EDITION**
AG827L

- High-modulus carbon-fiber core increases strength
- Carbon-composite exoskeleton reduces weight
- Rubber-isolated weighting system for maximum vibration dampening
- TRU•TOUCH™ soft-feel technical coating
- Adjustable Stainless-steel tuning weights
- Interchangeable colored dampening rings
- Length is 10"
- Weight is adjustable from 10 to 12 oz.





EXR HUNTER

- Rock solid & new features make the EXR HUNTER a Favorite
- (4) EXR Series Micro tube pins in .019" provide minimal target blockage
 - Tool-less adjustment for windage and elevation
 - 1.75" Advanced wire-frame housing design
 - New fixed plate design with integrated rheostat light included
 - Right or Left hand



XLR 2100MP

The EXTREME LONG RANGE (XLR) 3D or hunting sight.

- XLR Drive system with "Speed Zero" pre-set yardage indicator marks included
- (4) EXR Series Micro tube pins in .015" for EXTREME LONG RANGE Shooting
- 1.75" Advanced wire-frame housing design accepts powered lenses in 2X, 3X, 4X or 6X
- Integrated sun shade with logo and rheostat light included
- Second and third axis leveling adjustment
- Right or Left hand



EXR 1900

The EXR 1900 SNIPER Series is for Serious Long Range Accuracy

- EXR 1000 scope housing accepts powered lenses in 2X, 3X, 4X or 6X
- Integrated light system with rheostat light included
- Ultra-light wire-frame design is the perfect complement for today's bows
- Right or Left hand



TITAN X² STABILIZER

- The PERFECT! match for your new Mathews® bow
- New vibration chamber design
- Mathews® Harmonic Stabilizer™ installed in either heavy or lite versions
- Ultimate vibration dampening
- Available in 4" or 8" lengths
- Right or Left hand

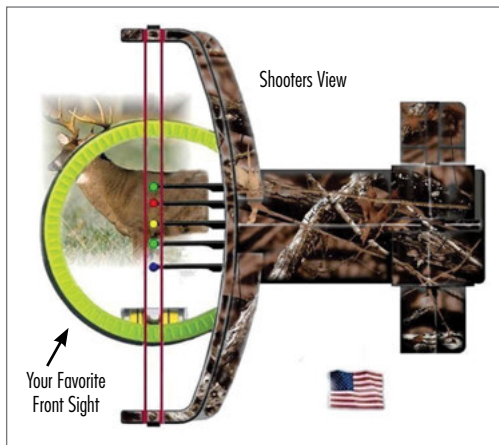

FINE LINE REAR BOW SIGHT

- Alerts of torque while focusing on your target
- Works with or can replace a peep
- Breaks habits of gripping the bow
- Trains shooters for repeatable form
- Works with your Front Sight



Schaffer

PERFORMANCE ARCHERY



ONLY 4.0 OUNCES

OPPOSITION AIR™

"Shockingly" Light . . . Amazingly Bright"

Opposed Pin Technology

- Spider Claw™ technology
- Brightest Fibers in the Industry
- Improved Field of View
- 100% Protected Fibers-Stainless Steel Pins
- Even Pins on Right - Odd Pins on Left
- Adjustable Light Available
- Available in 4 or 6 Pin

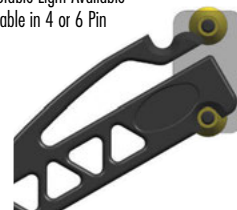

OPPOSITION LITE™

Real Containment

- Absolute Containment - Arrow cannot move, make noise or fall off the rest when locked
- Glide Away Technology - Bow can be drawn in the "open" or "locked" position
- Simple - Draw the bow and the arrow raises automatically
- 418 f.p.s. Tested
- Simplified Tuning -
- Universal mounting plates available for custom fit



SWORD SIGHTS

TWILIGHT HUNTER
SABRE

- Available in .010, .019 and .029 pins
- 100% made in USA.

SABRE



TWILIGHT HUNTER

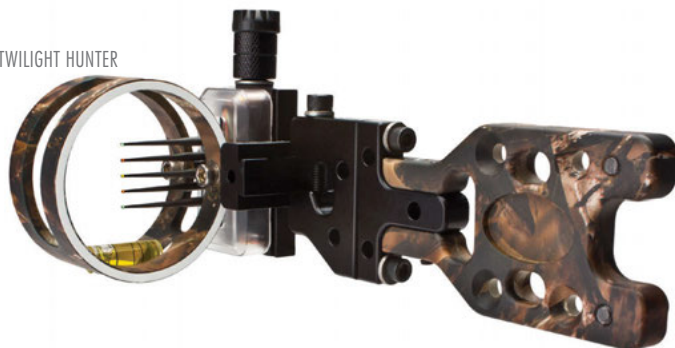

GET LOST
OR BE FOUND™



LOSTCAMO.COM

SIGHTS / STABILIZERS / RESTS



ACCUTOUCH

The AccuTouch Slider Sight with AccuClicks-Pick it! Click it! Stick it! With AXCEL's new patent-pending AccuTouch Slider Sight with AccuClicks, you can Pick your target, AccuClick your yardage, and Stick It! Includes Mathews® Harmonic Damper™. We have borrowed technology from our Olympic Gold medal-winning tournament sights and toughness from our multi-time Best Buy-winning ArmoTech sights to make the most accurate slider sight ever built.

FANG GS



FANG/FANG GS

Features a rubber insert in the trigger for improved feel. Two trigger options included in package; a straight trigger for more draw/speed and a relaxed trigger for greater comfort. Superior 2 screw trigger sensitivity setting, provided by a trigger travel adjustment screw, and a separate trigger pressure setting screw with choice of included varied weight springs. Available with a black anodized head with your choice of a Lost Camo® Velcro® strap or black leather buckle strap or Lost Camo® anodized head with your choice of a black Velcro® strap or black leather buckle strap.

FANG RC

Same great features as the Fang and Fang GS with a rope connection. Uses our new Red Rope Connection for quick and easy adjustment.



FANG 3 AND FANG 4

Featuring a Full Containment System (FCS) with a Hook-style jaw that allows the archer to push the FCS Slide forward to lock the release on the D-loop for use in a hands free hunting situation or pull the FCS Slide back for repetitive shooting. Ability to shoot with no sensitivity spring for the lightest possible setting as well as a medium and heavy spring, included in the package, for heavier sensitivity settings. A trigger travel adjustment screw allows numerous different settings. Adjustable thumb barrel positions can be attained with the large knurled thumb peg and teardrop. Pull the trigger to fire, then pull trigger again after firing to reset the hook. Three finger and four finger handles are available. Available in Lost Camo®.



LOC Outdoor

"Think Differently"



MAT-LOC 1

- New for 2015!
- Fold-up knuckle and disconnect in one complete and compact package!
- Knuckle option will lock straight out or fold upwards for storage in your case
- While in the fold up position, and your stabilizer becomes a handle after a long day in the woods or on the 3-D range.
- Use as a standard disconnect for stabilizer removal and storage
- Utilizes Mathews® Harmonic Damper™
- Black or Lost Camo® Bracket Finishes
- 10 Degree Down insert available
- Patent Pending



MEGA BRAID MAT-LOC WRIST SLING

- Our design is even BETTER for 2015!
- Wide Two-Tone Cobra Braid for a custom look
- Our new mounting bracket design will accommodate any bow and any stabilizer
- Mathews® Harmonic Dampers™ in our Sling-LOC adjustment knob system top off this sling
- Cobra Slings are available in 7 colors
- Black or Lost Camo® Bracket Colors
- Patent Pending



MAT-LOC CHUBB'E

- Our Chubb'E design gets an upgrade for 2015!
- Newly designed mounting bracket will accommodate any bow and any stabilizer
- New color option for back braid: Lost Camo
- Mathews® Harmonic Dampers™ in our Sling-LOC adjustment knob system for an awesome look!
- Black or Lost Camo® Bracket Finishes
- U.S. Patent No: D715,883 and others patents pending

OUTDOOR PROSTAFF



LOST CAMO® EDITION MATHEWS® LOGO BRANDED SHOULDER SLING

3" Shoulder strap with easy to adjust straps and quick release clips for comfort and ease. Available in Lost Camo® with the Mathews® logo, includes the popular phrase "Catch us if you can!®"

MATHEWS® LOGO LOST CAMO® EDITION WRIST WRAP SLING

Our slings are the most comfortable, and easiest wrist sling available! Available with the Mathews® logo and includes the Mathews® phrase "Catch us if you can!®" Also available with the Mission® Logo.

- Colors available include Lost Camo®, Lost Camo® AT, Red, Green, Orange, Pink, and Blue



 **Made with Pride in the USA**

OTHER ARMGUARDS AND GLOVES AVAILABLE FROM NEET.

SHOOTING GLOVE FG-25C-L

- Lost Camo® edition
- High quality construction
- Brushed finish material
- Elastic back insert for comfortable fit
- Hook and loop strap adjustment
- Smooth leather tips

Available Options:
Sizes: XS, S, M, L, XL



LIMBSAVER® By SVL SIMS VIBRATION LABORATORY

KODIAK-LITE BOW SLING

- Comfortable contour design evenly distributes weight
- Ergonomic hand grip
- Now with non-slip texture!



COMPRESSION SLEEVE ARMGUARD N-CMP

- Lost Camo® edition
- Slip on armguard
- Compression fit
- Padded strip for protection
- Provides shirtsleeve restraint

Available Options:
Sizes: S, M, L, XL



VENTED HUNTING ARMGUARD N-3V

- Lost Camo® edition
- Three nylon rod reinforcement staves
- Two adjustable elastic straps
- 6 3/4" x 3 5/8"

Available Options:
Hook and Loop connectors
Pull Adjust plastic buckles



STEADY FORM

STEADY FORM

"Every serious bowhunter knows the importance of consistent and accurate shooting at the moment of truth. One handy product that will help is the bow mounted Steady Form system which eliminates hand torque and improves arrow placement. Check it out for yourself." -M.R. James - Founder of Bowhunter Magazine and Archery Hall of Fame inductee.

Steady Form is an essential tool for any archer. For the beginning archer it helps to learn proper form and eliminate string slap. For the hunter, Steady Form increases down range accuracy and confidence. In the ground blind or treestand, Steady Form helps the hunter stay consistent with their form while having awkward shots through windows of the blind or sever downward angles. There is no other product that improves accuracy, consistency, confidence, creates another anchor point, prevents string slap and eliminates torque.

- Steady Form comes in a youth model, the Original, and now the new ProSeries in Lost Camo®, Lost Camo® AT and multiple other color options.
- ProSeries weighs 1.9 oz (Steady Form only)
- Guaranteed to increase accuracy and confidence or your money back.



WHITETAIL COUNTRY



SMARTPHONE BOW MOUNT

Capture your Hunt #GoNuts

- Review your shot placement just seconds after impact
- Share your hunt with family and friends directly from device to social network
- Rugged aluminum construction
- Tough Lost Camo® or Black Hydrographic finish
- Lightweight 5.5 oz
- Fits phones up to 3.6 inches in horizontal width
- Compatible with up to 2 inch max stabilizer diameter





ARCHERY SAFETY LOCK BY ACU ARCHERY, LLC

- Protect your Investment
- Dry Fire Protection
- Theft Deterrent
- Child Resistant
- American Made
- Aluminum Construction
- Teflon Impregnated Anodizing
- Laser Engraved
- Fits Most Compound Bows & Crossbows
- Great for Lock-up Laws
- Patent Pending

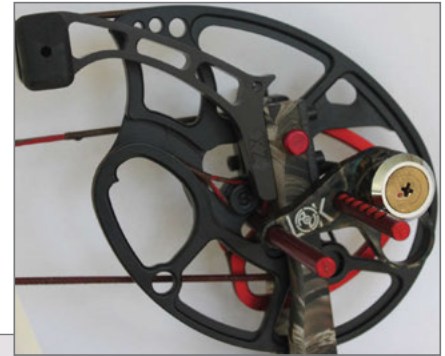

ACCESSORIES



CAMOFX® LOST CAMO® EDITION FACE PAINT SYSTEM CFXLC

CamoFX® Lost Camo® edition is equally effective in all kinds of terrain, western draws, fence lines, rocky hillsides or the Texas brush. The colors in Lost Camo® are found everywhere in the country, 12 months of the year. The Lost Camo® pattern is larger than most patterns on the market, which means it will stay effective even at long distances.





MORRELL

#1 Eternity Targets



MATHEWS® LOGO FIELD POINT TARGET

- 25" x 27" x 15" 32 lbs
- Patented Multilayered Density Design
- IFS Technology
- EZ Tote Carrying Handle
- Two Year Warranty
- Stops all hard hitting high speed bows
- Easy Arrow Removal
- X-tended Life Target
- Weatherproof

MATHEWS® LOGO BROADHEAD TARGET

- 22" x 20" x 18" 27 lbs
- Nucleus Center
- Weatherproof
- Great for fixed and mechanical blades
- Stops all hard hitting, high speed bows
- EZ Tote Carrying Handle
- Easy Arrow Removal



MATHEWS® HARMONIC DAMPER™ TARGET 16811

If you can't get enough Mathews® gear, here is the target for you. Made entirely of Rinehart's Signature "self healing" foam this target will stand up to the toughest practice session. Whether shooting broadheads, field points this target will last for years and arrow remove with ease.

Size: 17" x 17" x 13"



Grizzly

coolers

For a Lifetime.

Grizzly 20:

Ice Retention: 5 days, 3 hours
 Weight Pounds: 16
 Outside Dimensions:
 20"W x 13.375"D x 14.375"H
 Inside Dimensions:
 13.875"W x 9.25"D x 10.375"H
 Capacity:
 20 quarts

Grizzly 40:

Ice Retention: 6 days, 14 hours
 Weight Pounds: 22
 Outside Dimensions:
 25.5"W x 16"D x 15.5"H
 Inside Dimensions:
 18"W x 11"D x 12"H
 Capacity:
 40 quarts

Grizzly 75:

Ice Retention: 8 days, 6 hours
 Weight Pounds: 33
 Outside Dimensions:
 33.25"W x 14"D x 14"H
 Inside Dimensions:
 27.5"W x 13.5"D x 14.5"H
 Capacity:
 76 quarts



* Featured in Lost Camo® edition
 * Mathews® Officially Licensed Product



ACCESSORIES



KSB 1
 String Stop Bracket.
 Features Mathews® Harmonic Stabilizer™



RS1 & RS2
 RS1 - 5/16" String Stop Dampener
 RS2 - 3/8" String Stop Dampener
 Features Mathews® Harmonic Stabilizer™

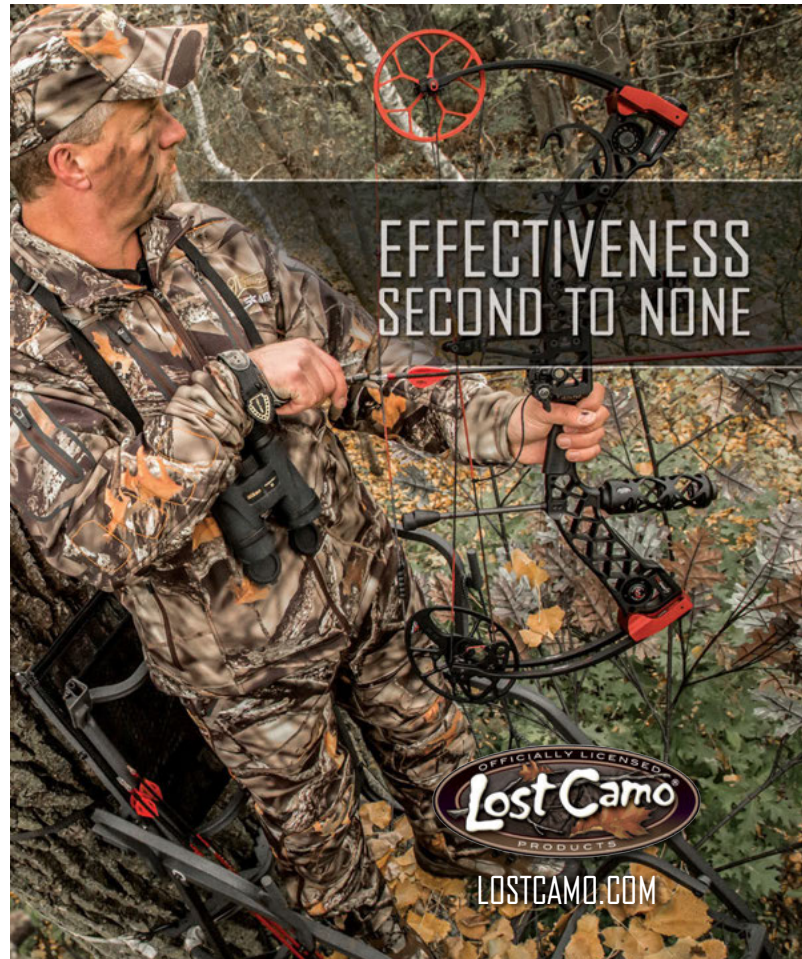

EFFECTIVENESS
 SECOND TO NONE



LOSTCAMO.COM



**TREE STAND
ARROW QUIVER CADDY**

- Accepts 99% of quiver mount brackets
- Position your quiver bracket at desired angle
- Will not corrode or rust
- Also available in NEW Lost Camo® AT Pink



EQUILIMB™

- Mathews® retailer exclusive
- Shim pack consists of four thicknesses to accommodate bow weight reduction
- Available in Lost Camo® and black
- Fit between bow riser and limb

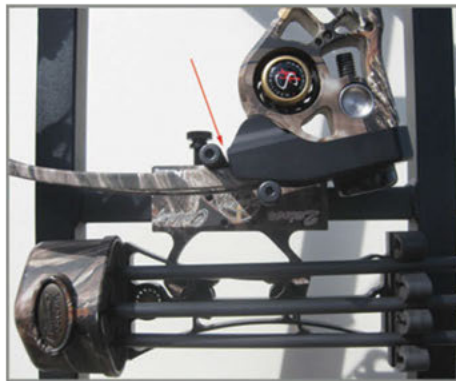

BOW PEGS

- Accessory for the Tree Stand Arrow Quiver Caddy
- Secure bow on stand at desired angle
- Available in 3" lengths

**Hold Up
DISPLAYS®
Firearm & Archery
Holders**

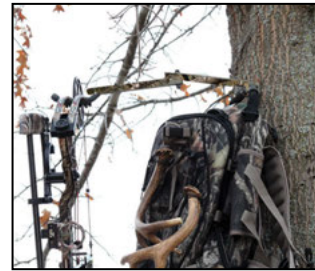

**LOST CAMO® AT EDITION
FOLDING BOW & PACK
HANGER**

HD55-LCAT

An official licensed Lost Camo® AT product. Super-sharp lag threads in easily & supports all of your archery equipment. Sturdy steel construction with durable powder coat finish & protective padding. Cradle end silently protects your bow. Folds smoothly for easy transport!



**LOST CAMO® EDITION
FOLDING BOW & PACK
HANGER**

HD55-LC

HD55-TWN-LC - Sold in a twin pack

An official licensed Lost Camo® product. Super-sharp lag threads in easily & supports all of your archery equipment. Sturdy steel construction with durable powder coat finish & protective padding. Cradle end silently protects your bow. Folds smoothly for easy transport!



**LOST CAMO® AT EDITION
FOLDING BOW & PACK
HANGER**

HD56-LCAT

An official licensed Lost Camo® AT product. Super-sharp lag threads in easily & supports all of your hunting equipment. Sturdy steel construction with durable powder coat finish & protective padding. Pivoting cradle silently holds the crossbow by the stirrup or limbs & the firearm by the stock. Folds smoothly for easy transport!

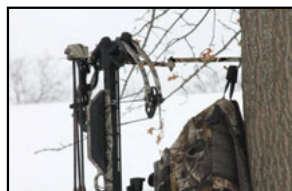



RAZOR-PRO MODEL #RO-20LC

Replaceable Razor-Blade/Gutting Blade Folder

Never sharpen your knife again with Outdoor Edge's new Razor-Pro double blade folder. Features a replaceable razor-blade knife plus our signature gutting blade to open game like a zipper without cutting hair or internal organs. To replace a blade, simply push the lock button to remove and insert a shaving-sharp new one. The black-oxide coated blade holder provides added support to the razor-blade for the strength of a traditional knife and sharpness of a surgeon's scalpel. Blaze orange rubberized handles ensure a secure, non-slip grip, even when wet and never get lost in the field. Each knife comes complete with six surgical 420 stainless steel razor-blades and a quality Lost Camo® edition nylon belt sheath. Replacement packs of 6-blades are sold separately.

Specifications

- Knife Blade: 3.5" (8.9cm)
- Gutting Blade: 3.2 (8.1 cm)
- Overall: 8" (20.3cm)
- Total Weight: 3.6 oz.
- Razor-Blade Steel: Japanese 420J2
- Vacuum heat treatment
- Gutting Blade Steel: Japanese AUS-8
- Handle: Rubberized TPR

Razor Pro: MSRP: \$79.95
6 Replacement Blade MSRP: \$14.95

RAZOR-BLAZE MODEL #RB-20LC

Never sharpen your knife again with Outdoor Edge's new patent pending replaceable razor-blade system. Simply push the lock button to remove and insert a shaving-sharp new blade. The black-oxide coated blade holder supports the razor-blade for surgeon scalpel sharpness with the strength of a standard knife. Blaze orange rubberized handles ensure a secure non-slip grip, even when wet and never get lost in the field. Each knife comes complete with six surgical 420 stainless steel razor-blades and a quality Lost Camo® edition nylon belt sheath. Replacement packs of 6-blades are sold separately.

Specifications

- Blade: 3.5" (8.9cm)
- Overall: 8" (20.3cm)
- Total Weight: 3.6 oz.
- Steel: Japanese 420J2
- Vacuum heat treatment
- Handle: Rubberized TPR

Razor-Blaze: MSRP: \$53.95
6 Replacement Blade MSRP: \$14.95



BEHRING TRADITIONS NESSMUK

The Nessmuk was made famous by the legendary conservationist and sportswriter, George W. Sears. This iconic pattern is designed to quickly remove the hide from any critter. Comfortable no matter how you grip it, this old school model will not disappoint.

- 3 1/4" Blade
- Brass Guard
- Leather & Stag Handle



BEHRING TRADITIONS STEALTH SKINNER

From the giant whitetails of the North woods to the bugling bulls of Montana, the Stealth Skinner is designed to be the perfect big game field knife. Combining a large cutting edge, finger grip, and thumb ramp, we have you covered when controlling your knife counts.

- 3 3/4" Blade
- Brass Guard
- Leather & Stag Handle



BEHRING PRO LT BACKCOUNTRY

The Backcountry is designed to be the perfect all around carry knife. It is the lightest and most compact model in our lineup. From the season opener to meat in the freezer; this classic is the only knife you will need.

- 4" Coyote Tan Cerakote™ Blade
- Black Paracord



BEHRING PRO LT DROP TINE

The Drop Tine is designed for the hunters accustomed to drop points. It is an excellent choice for whatever the hunt throws at you. Whether its prepping a big gobbler or working through the deer camp harvest, the Drop Tine is ready for the challenge.

- 4 1/2" Polished Blade
- Camo Paracord





LD 360 SKIRT

- Poly 600 fabric with urethane black backing
- Wraps around shooting rail & connected with snaps
- Zippered entrance
- Elastic sewn into bottom for tighter fit



LD14 SKIRT

- Poly 600 fabric with urethane black backing
- Wraps around shooting rail & connected with snaps
- Wraps around backside of stand to conceal lower torso
- Zippered entrance



DD 14 SKIRT

- Poly 600 fabric with urethane black backing
- Wraps around shooting rail & connected with snaps
- Wraps around backside of stand to conceal lower torso
- Zippered entrance



DBL-TRI SKIRT

- Poly 600 fabric with black backing
- Wraps around shooting rail & connected with snaps
- Zippered entrance
- Two gear pockets
- Elastic sewn into bottom



BIG MIKE™ BMO1LC

- 80 inches tall for standing shots
- Versatile 5-panel windows can be opened vertically and horizontally
- Portable with carry bag



SHOOT WHILE STANDING



BOWMAN™ RE638

- At 19' 9" in height, the Bowman™ is tall enough to help you avoid being winded
- The TearTuff™ mesh seat is silent, durable, comfortable and flips up for full platform use

DESIGNED FOR
BOWHUNTERS



DOMINATOR

Dominate the woods with the light weight superior design of the Dominator. Ultra lightweight with roomier platform and larger seat.

Key features include a closed cell padded cushion to prevent water absorption. A heavy duty ratchet with rubber coated wire hooks to secure the bottom of the stand. Bronze oilite bushings provide quiet pivot points and a durable powder coated finish. Comes with TMA certified safety harness.

SPECS & FEATURES

Construction: Aluminum Rating: 300 lbs. Seat Cushion: 16" x 10" x 4" Foam
Weight: 10.25 lbs. Platform Size: 30" x 27" Seat Height: 22" x 15" x 10"





"We lure, you hunt."

Iowa Dept. of Ag Certified
Closed, Healthy Whitetail herd,
CWD monitored 12 Yrs.



**LOST CAMO® EDITION
DOE IN ESTRUS LURE**

Mrs. Doe Pee's Bucklure specializes in maintaining the integrity of the whitetail does' Estrus Pheromones, the way nature intended, and BIG BUCKS expect!

Now available in 3 convenient amounts:

2 oz. APPLICATOR:

Drip, squirt, or spray a fine mist. Simply refrigerate the unused portion. **BEST SELLER!**

4 oz. BOTTLE:

Fill the empty 2 oz. with the amount needed for the days hunt while keeping the larger bottle fresh in the refrigerator.

6 oz. COMBO PACK:

2 oz. filled applicator, and 4 oz. bottle. Best buy for the multi-day hunter. Use it pre-rut, during the rut, and post rut. Refrigerate the unused product after the days hunt.



NOSE JAMMER®

WRONG WIND? JAM 'EM!

NOSE JAMMER

Lost Camo® Edition
12 count display 6 oz aerosol cans.

- Utilizes vanillin and other compounds found in trees.
- Delivered at concentrated levels to effectively overload sense of smell.

OZONICS™

THE NEW LEADER IN SCENT-CONTROL TECHNOLOGY

HR-200

Blankets your scent zone with scent-destroying ozone so deer won't smell you!

- Treestand/Blind
- Electronically changes oxygen to ozone
- Quiet, built-in fan projects ozone downwind
- Easily mounts to tree or blind
- Rechargeable 12-volt battery included

HR-200
LOST CAMO® EDITION



HR-200 NATURAL



SCENT CONTROL / LURES



CHARGED WITH
COPPER
CATALYST

ODOR ELIMINATOR

2 oz. trigger spray convenient pack/
pocket size, 8 oz, 16 oz and 32 oz

- Safely eliminate odors on contact
- Continuous catalytic action lasts for hours
- Safe to use on skin
- Patented MCC copper ion odor elimination technology
- No Odor of its own
- No Residue

Refill for the 32 oz. spray available, just add water with our 2 oz. Super Concentrate to refill the bottle.



ODOR ELIMINATING HAIR AND BODY WASH

- 8 oz
- Scent Free Odor Eliminating Hair and Body Wash
 - Effectively removes sweat, dirt, blood and odors
 - Use prior to hunting for complete odor control
 - Patented MCC copper ion odor elimination technology



ODOR ELIMINATING FOAM MOUTH WASH

- 2 oz
- Eliminates bad breath and leaves your mouth feeling fresh
 - Patented oral care formulation using MCC copper ion odor elimination technology
 - Convenient size for your pack or pocket



ODOR ELIMINATING LAUNDRY DETERGENT

- 32 oz
- Scent Free Odor Eliminating Laundry Detergent
 - Effectively removes set sweat, dirt, oil, grease, blood and odors
 - Patented MCC copper ion odor elimination technology



TO SEE MORE OFFICIALLY LICENSED PRODUCTS VISIT LOSTCAMO.COM



COVERT

SCOUTING CAMERAS



**MP8 BLACK
LOST CAMO®
EDITION**
C02946

- 8MP Pictures
- 640X480 Video
- 40 Black Flash LED's (No Glow)
- 45 ft. Flash Range
- Excellent Battery Life
- Built-in Color Viewer



**MP8
LOST CAMO®
EDITION**
C02960

- 8MP Pictures
- 640X480 Video
- 28 Red Glow LED's
- 45 ft. Flash Range
- Excellent Battery Life
- Built-in Color Viewer



HOTSHOT 3

FILM YOUR VISION

**HOTSHOT 3
HD 1080**

Included with this camera

- Hot Shot 3 Cam HD 1080
- 30MM pica tinny rail scope ring
- 1 inch pica tinny rail scope ring
- Camera pica tinny rail mount
- Lithium-ion battery
- USB 2.0 cable
- TV/RCA cable
- Car charger
- 110 volt charger
- HDMI cable



SPYPOINT®

M8 TRAIL CAMERA

LOST CAMO® EDITION

The SPYPOINT® M8 BLACK LEDs game camera captures 8-megapixel color photos by day and black-and-white photos at night and 10 to 90 sec. videos with sound. The M8 camera uses high-power invisible BLACK LEDs. The M8 model is the perfect camera to avoid spooking the game and this camera is a popular unit for security purposes because of the invisible BLACK LEDs. The 5 zone sensor will give you a faster trigger speed and ensures you get more centered images. The distance detection sensor can be adjusted from 5' to 50' and the multi-shot mode allows up to 4 pictures per detection. The removable internal camera makes this camera one of the easiest to use on the market.

- 8 Megapixels
- 46 LEDs
- Invisible BLACK LEDs
- Video with sound recording



ADD-A-CAM™

With the Stic-N-Pic® Add-A-Cam™ you can attach multiple cameras to the Stic-N-Pic® Trail Camera Stand or Tree Mounts and capture the 360-degree view of your entire landscape.

- Mount multiple cameras on one mount
- Adjustable camera height
- Adjustable tilt/pan
- 360-degree rotation

Now Available, Our New Mini Ground Mount. Contact Us for Details.

TRAIL CAMERA STAND

The Stic-N-Pic® Trail Camera Stand gives you the freedom to decide where your camera should go, quickly: on or off the trail—even in between bedding and feeding areas. Get in, get out.

- Adjustable camera height (25"-51")
- 360-degree rotation
- Add-A-Cam™ allows for multiple cameras on one stand
- Adjustable tilt/pan
- 3 prong stand fits securely in the ground

Trail Camera Mounting System



TRAIL TREE MOUNTS

Stic-N-Pic® Tree Mounts give you the versatility to have precise scouting tools necessary to give you that extra edge.

- Installs quickly
- Adjustable camera tilt
- 360-degree rotation
- Add-A-Cam™ allows for two cameras on one mount
- Adjustable tilt/pan



UNIVERSAL BRACKET

For trail cameras that do not have a tripod mount, but do have a bungee or strap mount, the Stic-N-Pic® Universal Bracket will allow you to attach your trail camera to our entire product line.

- Installs tripod mounts to most cameras
- Installs quickly and easily

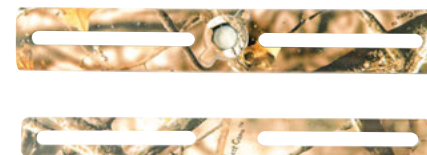



We make it visible.

/ TERRA *ED*

TERRA ED BINOCULARS

TERRA ED binoculars offer an exceptional visual experience thanks to SCHOTT ED glass with ZEISS MC multi-coated lenses, images are always bright and clear - even in low light conditions. Comfortable ergonomics and robust, lightweight and waterproof construction, TERRA ED binoculars are built to handle rugged terrain and harsh conditions. With a stunning 5.25 ft. close focus and a generous wide field of view, you'll never miss a thing. The compact size makes TERRA ED extremely mobile in the field. All TERRA ED binoculars are backed by ZEISS' U.S. limited lifetime transferable warranty.

The 8x42 and 10X42 models will accommodate nearly every situation. Both available in either Lost Camo® edition or Black.

Key features:

- Absolute best-in-class optical and field performance
- Smooth reliable focusing system
- Designed, engineered, and quality-assured by ZEISS



High-Tech Design. World-Class Sound.



Delivers a bigger, fuller sound than many traditional jumbo acoustics are able to produce.

- Not affected by cold or heat – great for camping, picnics or any outdoor activity
- Incredibly stabile construction and hardware Stays in tune longer
- Smaller, lightweight 100% carbon fiber body
- All new carbon technologies with several Patents Pending

Now available in these finishes:



Carbon Fiber



Lost Camo®



Lost Camo® OT



Kevin Michael™

MADE IN THE USA BY *McPherson* GUITARS

CARBON FIBER

MCPHERSONGUITARS.COM



LOSTCAMO.COM
919 RIVER ROAD, SPARTA, WI 54656